

# CONDENSING GAS-FIRED STORAGE WATER HEATER.

WHC400

WHC500

WHC700

WHC900

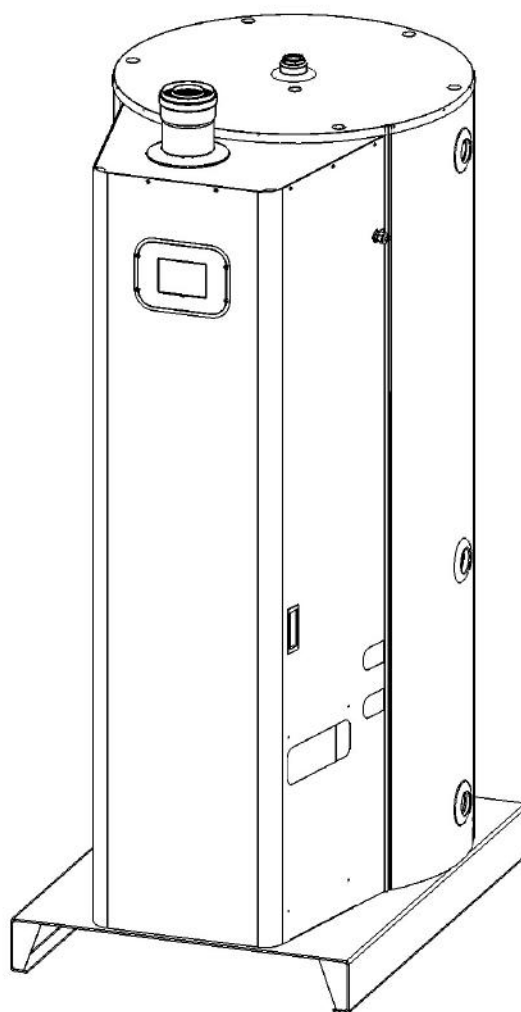

## ENG - Manual of installation, use and maintenance.

Read and follow these instructions before installing the unit.

Always keep on hand this manual during any servicing intervention.

This manual is also available in the electronic format and can be downloaded from the website

[www.atimariani.it](http://www.atimariani.it)

Jan-19

**INDEX**

1.	GENERAL WARNINGS .....	3
2.	TRANSPORT, STORING AND RECYCLING .....	4
3.	CORRECT DISPOSAL OF THE PRODUCT.....	4
4.	CONTENT, WEIGHT AND PACKAGING DIMENSIONS .....	5
5.	APPLIANCE CATEGORIES .....	5
6.	TECHNICAL SPECIFICATIONS .....	6
7.	COUNTRIES OF DESTINATION AND GAS CATEGORIES.....	6
8.	APPLIANCE DIMENSIONS AND FEATURES .....	7
9.	THE INSIDE OF THE APPLIANCE .....	8
10.	FUNCTIONAL AND STRUCTURAL DESCRIPTION .....	9
11.	COMPONENTS OF THE BOILER .....	10
12.	CONTROL PANEL DISPLAY .....	11
13.	SAFETY AND INSTALLATION LOCAL REGULATIONS.....	11
14.	INSTALLATION.....	13
15.	POSITIONING THE APPLIANCE .....	13
16.	FLUE SYSTEM .....	14
17.	WATER CONNECTION .....	16
18.	GAS CONNECTION.....	17
19.	ELECTRICAL CONNECTIONS.....	17
20.	STARTING AND TEMPERATURE ADJUSTMENT.....	18
21.	GAS SETTING AND CHANGING OF GAS TYPE .....	20
22.	MENU PARAMETERS AND DESCRIPTION .....	23
23.	ANTILEGIONELLA FUNCTION .....	25
24.	ELECTRONIC BOARD AND WIRING.....	26
25.	OTHER SYSTEM FEATURES.....	29
26.	FAULTS .....	29
27.	SAFETY ANOMALIES .....	29
28.	PROBES FAULTS .....	34
29.	FAN FAULTS .....	36
30.	FAULTS FLOW.....	38
31.	SERVICING THE HEAT EXCHANGER .....	39
32.	PERIODIC MAINTENANCE .....	39
33.	WARRANTY VALIDATION .....	39

## 1. GENERAL WARNINGS

- ⚠ THIS BOOKLET IS AN INTEGRAL AND ESSENTIAL PART OF THE APPLIANCE AND MUST BE KEPT WITH CARE NEXT TO IT FOR ANY FUTURE REFERENCE. IT CONTAINS IMPORTANT INFORMATION REGARDING SAFETY, INSTALLATION, OPERATION AND MAINTENANCE.
- ⚠ THE APPLIANCE IS DESIGNED FOR HOT WATER PRODUCTION ONLY: ANY OTHER USE OF IT IS UNSUITABLE AND DANGEROUS.
- ⚠ THE APPLIANCE SHOULD NOT BE INSTALLED IN DAMP ROOMS AND HAS TO BE PRESERVED BY SPRINKLINGS OF WATER OR OTHER LIQUIDS, TO AVOID DAMAGES TO ELECTRICAL AND THERMAL DEVICES.
- ⚠ A QUALIFIED PERSON, WHO IS RESPONSIBLE FOR THE IMPLEMENTATION OF THE EXISTING SAFETY STANDARDS, MUST PERFORM THE INSTALLATION. AN IMPROPER INSTALLATION, CAUSED BY THE NON-OBSERVANCE OF THE MANUFACTURER'S INSTRUCTIONS, MAY CAUSE INJURY TO PERSONS, ANIMALS OR DAMAGES, FOR WHICH THE MANUFACTURER DECLINES ALL RESPONSIBILITY.
- ⚠ KEEP ALL PACKAGING MATERIAL (PLASTIC BAGS, POLYSTYRENE, WOOD, CLIPS, ETC.) OUT OF REACH OF CHILDREN AS IT MAY PRESENT A POTENTIAL HAZARD.
- ⚠ THE APPLIANCE IS NOT INTENDED FOR USE BY CHILDREN AGED LESS THAN 8 YEARS AND BY PERSONS WITH REDUCED PHYSICAL, SENSORY OR MENTAL CAPACITIES, LACK OF EXPERIENCE OR KNOWLEDGE, UNLESS THEY HAVE BEEN GIVEN SUPERVISION OR INSTRUCTIONS CONCERNING THE USE OF THE APPLIANCE BY A PERSON RESPONSIBLE FOR THEIR SAFETY.
- ⚠ CHILDREN SHALL NOT PLAY WITH THE APPLIANCE.
- ⚠ CLEANING AND MAINTENANCE, INTENDED TO BE CARRIED OUT BY THE USER, SHALL NOT BE MADE BY CHILDREN WITHOUT SUPERVISION.
- ⚠ IF THE APPLIANCE IS SOLD OR TRANSFERRED TO ANOTHER OWNER, MAKE SURE THAT THIS BOOKLET STAYS WITH THE APPLIANCE, SO THE NEW OWNER AND / OR INSTALLER CAN CONSULT IT.
- ⚠ DO NOT PUT ANYTHING ON THE TOP OF THE APPLIANCE. IN ORDER TO AVOID DAMAGES CAUSED BY FROST, DRAIN THE TANK COMPLETELY, IN THE EVENT THE APPLIANCE IS LEFT UNUSED FOR A LONG PERIOD IN A NON HEATED ROOM. THE MANUFACTURER IS NOT RESPONSIBLE FOR FAULTY OPERATIONS OR BROKEN PARTS CAUSED BY FROST AND FOR WATER LEAKAGE FROM THE PLANT.
- ⚠ TO GET THE BEST PERFORMANCE AND THE WARRANTY VALIDATION, WE RECOMMEND TO FOLLOW THE INSTRUCTIONS HERE BELOW AND TO USE ONLY ORIGINAL SPARE PARTS AND KITS PROVIDED BY THE MANUFACTURER.
- ⚠ MORE APPLIANCES IN THE SAME ROOM, FOR A TOTAL THERMAL CAPACITY HIGHER THAN 35 KW, ARE A HEAT STATION AND ARE SUBJECT TO THE PROVISION OF THE FIREMEN CIRCULAR NO. 68.
- ⚠ IT IS STRICTLY FORBIDDEN TO TAMPER ANY DEVICE FACTORY SET AND SEALED BY THE MANUFACTURER.

## 2. TRANSPORT, STORING AND RECYCLING

- The appliance must be transported and stored under cover and protected from frost.
- The appliance must not be handled and / or laid horizontally: it can be transported only in a vertical position.
- Handle the unit by means of a forklift or a manual pallet truck. Enter the parallel arms of the forklift in the lower part of the appliance, as shown in the picture below.

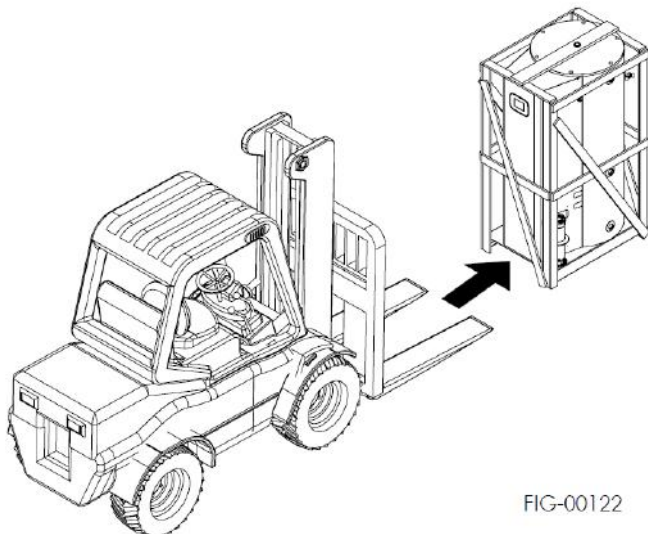

FIG-00122

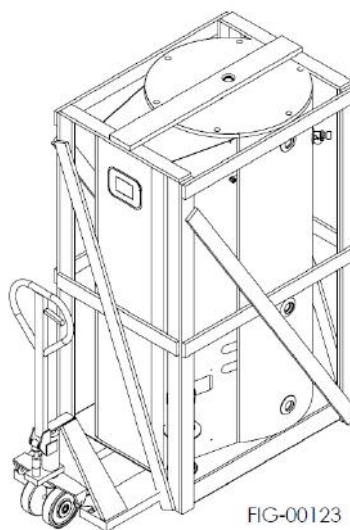

FIG-00123

- Remove the packaging by undoing the 4 screws at the bottom corners of the appliance, then pull upwards the packaging, being careful not to damage the appliance.

## 3. CORRECT DISPOSAL OF THE PRODUCT



The symbol shown on the equipment indicates that waste must be disposed of in “separate collection” and so the product must not be disposed of together with urban waste. The user must take the product to special “separate waste collection centres” provided by local government, or deliver it to the retailer against the purchase of a new product. Separate collection of waste and subsequent treatment, recycling and disposal operations promotes the production of equipment with recycled materials and limits negative effects of waste. Illegal disposal of the product leads to the enforcement of administrative penalties.

## 4. CONTENT, WEIGHT AND PACKAGING DIMENSIONS

The appliance is delivered packaged in a wooden cage with appropriate protection. See table below for size.

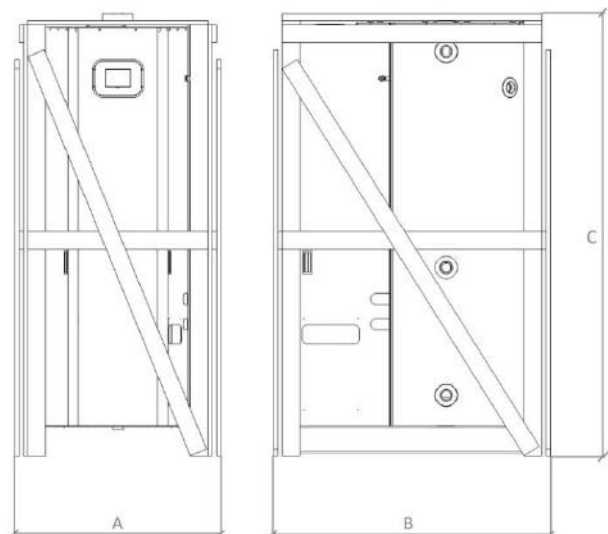

Dimensions in mm - Weight in kilograms: Kg

	WHC400	WHC500	WHC700	WHC900
<b>A</b>	820	820	1030	1030
<b>B</b>	1100	1100	1300	1300
<b>C</b>	1740	2100	1800	2170
<b>Weight with packaging</b>	203	229	259	297

## 5. APPLIANCE CATEGORIES

These appliances are classified as: "Condensing gas fired storage water heaters".

- Gas Categories: I2H, I3P I2L and derived second categories
- TYPE C Appliance classes (EN 483) (see table):

**C63** appliance connected to an air intake and flue outlet approved system and sold separately; the fan is upstream of the heat exchanger.

**C53** appliance connected to two points having a different pressure; the fan is upstream of the heat exchanger.

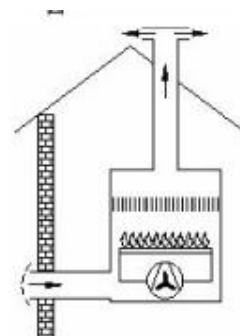

**C33** appliance connected to coaxial or twin pipe flue system so close to have the same vertical wind conditions (roof) with fan upstream of the heat exchanger.

**C13** appliance connected to coaxial or twin pipe flue system so close to have the same wind conditions (horizontally through the wall) with fan upstream of the heat exchanger.

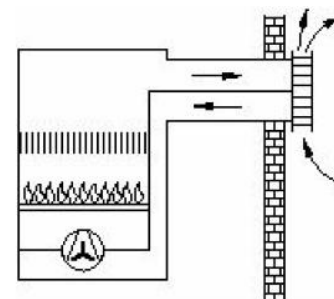

**C43** appliance connected to coaxial or twin pipe flue system so close to have the same wind conditions, which intakes air from the chimney and with fan upstream of the heat exchanger.

**C83** appliance connected to twin pipe flue system with air intake from the outside and flue outlet through the chimney; the fan is upstream of the heat exchanger.

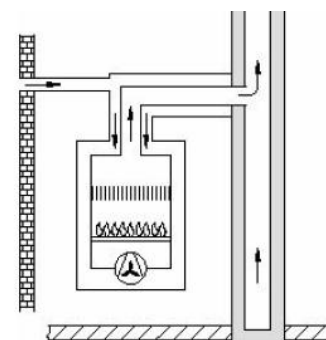
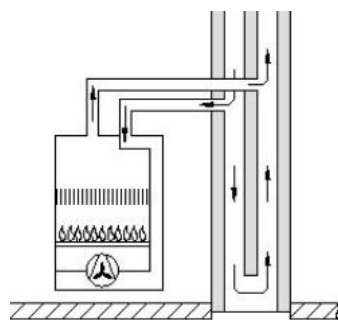

## 6. TECHNICAL SPECIFICATIONS

		WHC400	WHC500	WHC700	WHC900
Classe efficienza sanitaria - <i>efficiency class</i>		A	B	B	A
Profilo di carico - <i>load profile</i>		XXL	XXL	XXL	XXL
Capacità nominale serbatoio - <i>tank nominal capacity</i>	l	395	500	700	856
Efficienza - <i>efficiency</i>	%	84	78	78	116
Portata termica nominale Q - <i>nominal calorific flow rate QN</i>	kW	25	25	25	25
Portata termica minima Q - <i>minimum calorific flow rate Qm</i>	KW	5	5	5	5
Potenza termica nominale P - <i>nominal power output PN</i>	KW	24,5	24,5	24,5	24,5
Potenza termica minima P - <i>minimum power output Pm</i>	KW	8,3	8,3	8,3	8,3
Consumo gas - <i>gas consumption</i>	m <sup>3</sup> /h	2,7	2,7	2,7	2,7
Temperatura fumi - <i>flue gas temperature</i>	°C	68	68	68	68
Valore di emissione di NOx - <i>NOx emission value</i>	mg/kWh	53	53	53	53
Pressione max acqua - <i>max water pressure</i>	kPa (bar)	600 (6)	600 (6)	600 (6)	600 (6)
η combustione - <i>H combustion</i>	%	98	98	98	98
η acqua - <i>H water</i>	%	99	102	100	100
Prelievo continuo Δ 25°C - <i>Δ 25°C water spillage</i>	l/h	841	841	841	841
Grado di protezione - <i>protection level for electrical appliance</i>	IP	21	21	21	21
Potenza elettrica nominale - <i>nominal electric power</i>	W	51	51	51	51
Caratteristiche elettriche - <i>Electrical characteristics</i>	V/Hz	230V ~ 50Hz	230V ~ 50Hz	230V ~ 50Hz	230V ~ 50Hz

## 7. COUNTRIES OF DESTINATION AND GAS CATEGORIES

Country (EN ISO 3166-1):	Category:	gas type / pressure (EN 437):
AL	I2H, I3P II 2H3P	G20 - 20 mbar; G31 - 37 mbar
AT	I2H	G20 - 20 mbar
BE	I2H, I3P II 2H3P	G20 - 20 mbar; G31 - 37 mbar
BG	I2H, I3P II 2H3P	G20 - 20 mbar; G31 - 37 mbar
CH	I2H, I3P II 2H3P	G20 - 20 mbar; G31 - 37 mbar
CY	I2H	G20 - 20 mbar
CZ	I2H, I3P II 2H3P	G20 - 20 mbar; G31 - 37 mbar
DE	I2E	G20 - 20 mbar
DK	I2H	G20 - 20 mbar
EE	I2H	G20 - 20 mbar
ES	I2H, I3P II 2H3P	G20 - 20 mbar; G31 - 37 mbar
FI	I2H	G20 - 20 mbar
FR	I2H, I2Er, I2Esi, I3P II 2H3P, I12Esi3P	G20 - 20 mbar; G25 - 25 mbar; G31 - 37 mbar
GB	I2H, I3P II 2H3P	G20 - 20 mbar; G31 - 37 mbar
GR	I2H, I3P II 2H3P	G20 - 20 mbar; G31 - 37 mbar
HU	I2H, I3P	G20 - 25 mbar; G31 - 37 mbar
IE	I2H, I3P II 2H3P	G20 - 20 mbar; G31 - 37 mbar
IT	I2H, I3P II 2H3P	G20 - 20 mbar; G31 - 37 mbar
LT	I2H, I3P II 2H3P	G20 - 20 mbar; G31 - 37 mbar
LU	I2H	G20 - 20 mbar
LV	I2H	G20 - 20 mbar
MK	I2H, I3P II 2H3P	G20 - 20 mbar; G31 - 37 mbar
MT	I2H	G20 - 20 mbar
NL	I2L, I3P II 2L3P	G25 - 25 mbar; G31 - 37 mbar
NO	I2H	G20 - 20 mbar
PL	I2E; I3P II 2E3P	G20 - 20 mbar; G31 - 37 mbar
PT	I2H, I3P II 2H3P	G20 - 20 mbar; G31 - 37 mbar
RO	I2H, I2E; I3P II 2H3P	G20 - 20 mbar; G31 - 37 mbar
SE	I2H	G20 - 20 mbar
SI	I2H, I3P II 2H3P	G20 - 20 mbar; G31 - 37 mbar
SK	I2H, I3P II 2H3P	G20 - 20 mbar; G31 - 37 mbar
TR	I2H	G20 - 20 mbar

## 8. APPLIANCE DIMENSIONS AND FEATURES

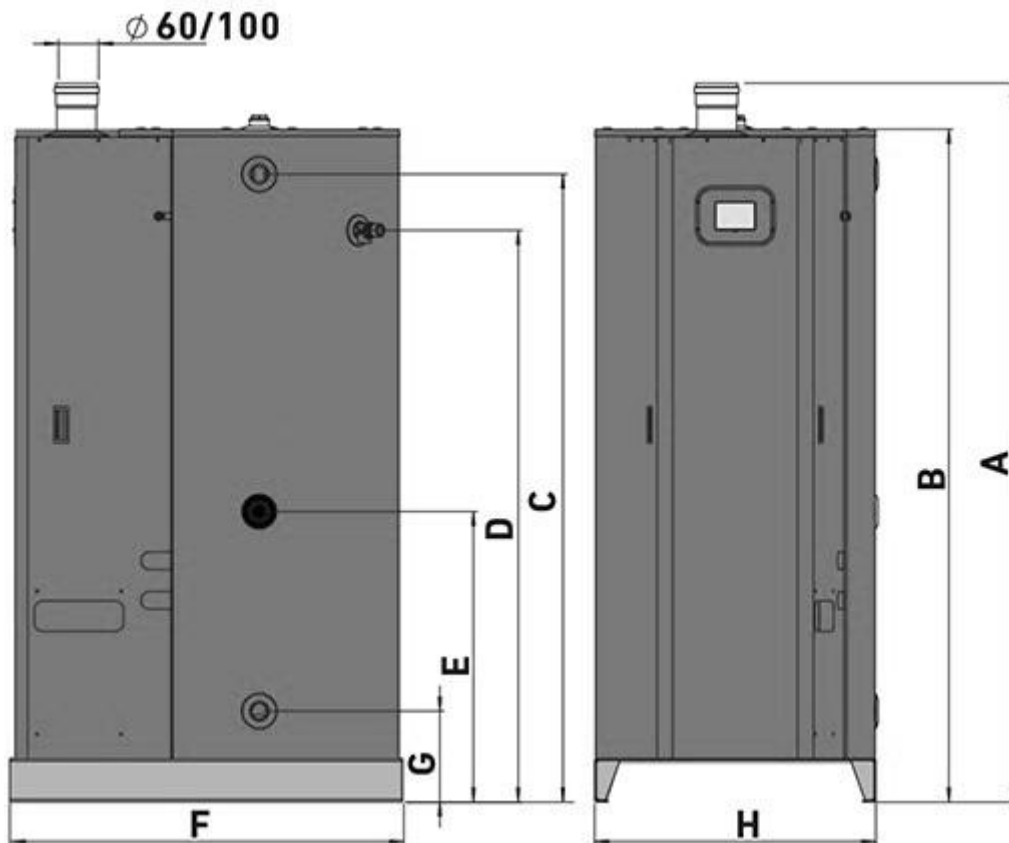

	WHC400	WHC500	WHC700	WHC900
A FLUES IN & OUT	1810	1810	1810	1810
B HEIGHT	1699	2049	1754	2114
C HOT WATER OUTLET G 1-1/4"	1585	1936	1641	1999
D SAFETY VALVE	1443	1443	1462	1462
E RETURN G 1"	733	733	752	752
F DEPTH	990	990	1190	1190
G COLD WATER INLET G 1-1/4"	229	229	205	205
H WIDTH	710	710	920	920

Dimensions in millimeters: mm

## 9. THE INSIDE OF THE APPLIANCE

The following instructions will show the internal components of the heating boiler, their configuration and maintenance. Remove the frontal casing of the appliance to carry out these interventions.

1. remove the screws from both the left and right side, by means of a common screwdriver (not supplied);
2. remove the screws from the lower part of the appliance;
3. paying attention to the upper gland, unscrew the nut on the opposite side of the sheet, so to push the cable out of the sheet slot, then leave the cable free;
4. it is now possible to remove the whole front bonnet by means of the handles on both sides of the appliance.

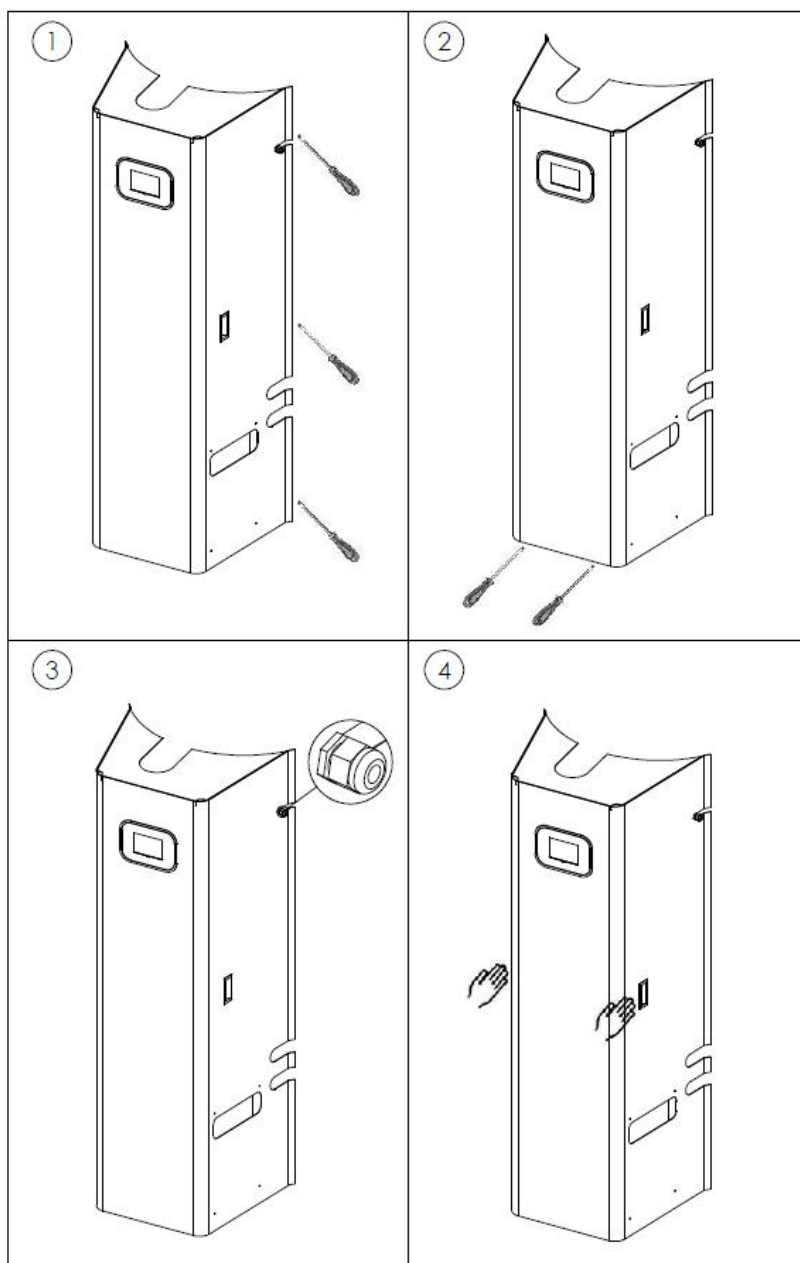

FIG-00139

To reassemble the bonnet, follow the instructions in reverse.

**PAY ATTENTION TO THE STEEL RIMS, BECAUSE THEY MAY BE SHARP: THE USE OF PROTECTIVE EQUIPMENT IS RECOMMENDED. THE MANUFACTURER DOES NOT ASSUME ANY RESPONSIBILITY FOR POSSIBLE INJURIES.**



## 10. FUNCTIONAL AND STRUCTURAL DESCRIPTION

The purpose of this appliance is to allow the heat exchange between the combustion products of the premix burner and the water stored in the tank through a heat exchanger that is in contact with the burner.

The combustion is completely sealed with respect to the place where the appliance is installed, taking in the air required for combustion from the outside and discharging the combustion products always outside.

The sealed combustion chamber is placed in the front part of the appliance, inside the casing.

A siphon, which grants the condensate drain, is placed at the bottom of the appliance.

### TANK

It is built with a sturdy sheet and grants a remarkable resistance to pressure. It is also subject to an internal glass lining treatment. A Ø120 flange allows the inspection and cleaning of its internal surface.

### HEATING BOILER

It is placed in the front part of the appliance and is composed of: burner, heat exchanger, gas valve, premix fan. The chamber is airtight with respect to the place where the appliance is located.

### 3-WAY VALVE

It is used to allow an accurate maintenance of the internal heat exchanger.

### WATER PUMP AND FLOWMETER

They are located under the boiler. The water pump collects the water from the tank and pushes it vertically towards the heat exchanger. The flowmeter senses the flow rate values and transmits them to the control board.

### FLUE KITS (it is compulsory to install the kit provided by the appliance manufacturer)

To be chosen amongst those available, according to the installation requirements. It allows the connection of the combustion chamber with the outside, bringing the combustion air to the burner and discharging flues.

### MAGNESIUM ANODE

The appliance is factory equipped with two magnesium anodes in order to protect the device from galvanic currents that can corrode the interior surface of the appliance. One anode is installed on the inspection flange, the other one is located in the upper part of the appliance.

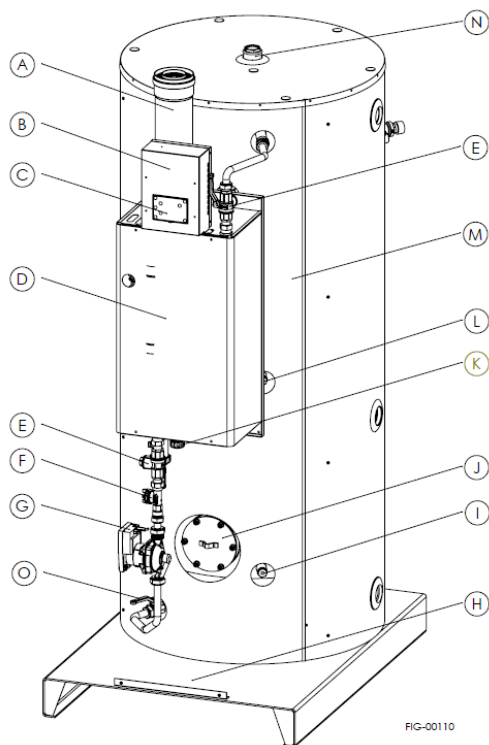

- A. AIR IN & OUT
- B. CONTROL BOX CASING
- C. CONTROL PANEL DISPLAY
- D. HEATING BOILER
- E. 3-WAY VALVE
- F. FLOWMETER
- G. WATER PUMP
- H. BASEMENT – HANDLING POINT
- I. LOWER PROBE
- J. INSPECTION FLANGE WITH ANODE
- K. CONDENSATE DRAIN
- L. MIDDLE PROBE
- M. STORAGE TANK
- N. UPPER ANODE
- O. BALL VALVE

## 11. COMPONENTS OF THE BOILER

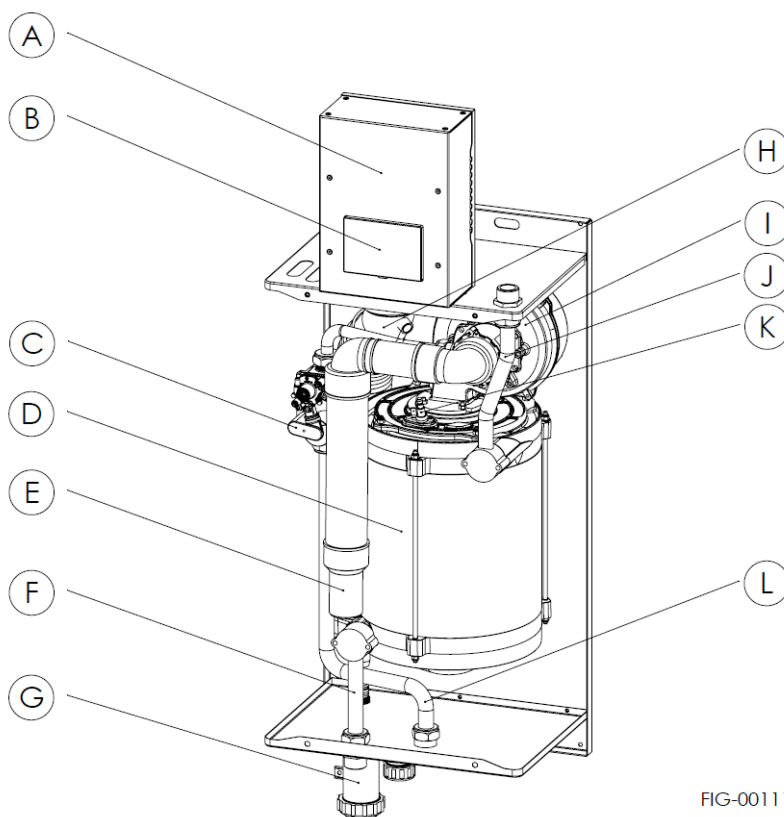

FIG-00111

### A. CONTROL BOX CASING

Protective cover of the electronic control box and earthing point.

### B. CONTROL PANEL DISPLAY

It is used by the operator to ensure the full control of the appliance software.

### C. GAS VALVE

Located on the left side of the heat exchanger, it adjusts the inlet gas flow to the premix fan.

### D. HEAT EXCHANGER

It consists of a stainless steel coil and allows the heat exchange between the combustion heat and the sanitary hot water of the boiler.

### E. AIR CHANNEL

It is used for channeling the incoming air to the injector holder. The air intake is done through the coaxial outer tube.

### F. WATER INLET

Copper-brass pipe for the water extraction from the boiler.

### G. CONDENSATE DRAIN

A siphon is located under the boiler: it collects condensate. It is necessary to discharge condensate by means of a flexible tube and to collect it in a system specially conceived for this purpose.

### H. FLUE OUTLET

Flue pipe. A condensate trap is placed at its bottom.

### I. FAN

The fan is used to mix air and gas before the burner.

### J. WATER OUTLET

Copper-brass pipe for the hot water outlet from the heat exchanger.

### K. ELECTRODES

Two electrodes (an ignition and a detection one) are located in the upper part of the heat exchanger.

### L. GAS INLET PIPE

copper-brass pipe for the gas inlet into the appliance.

### 12. CONTROL PANEL DISPLAY

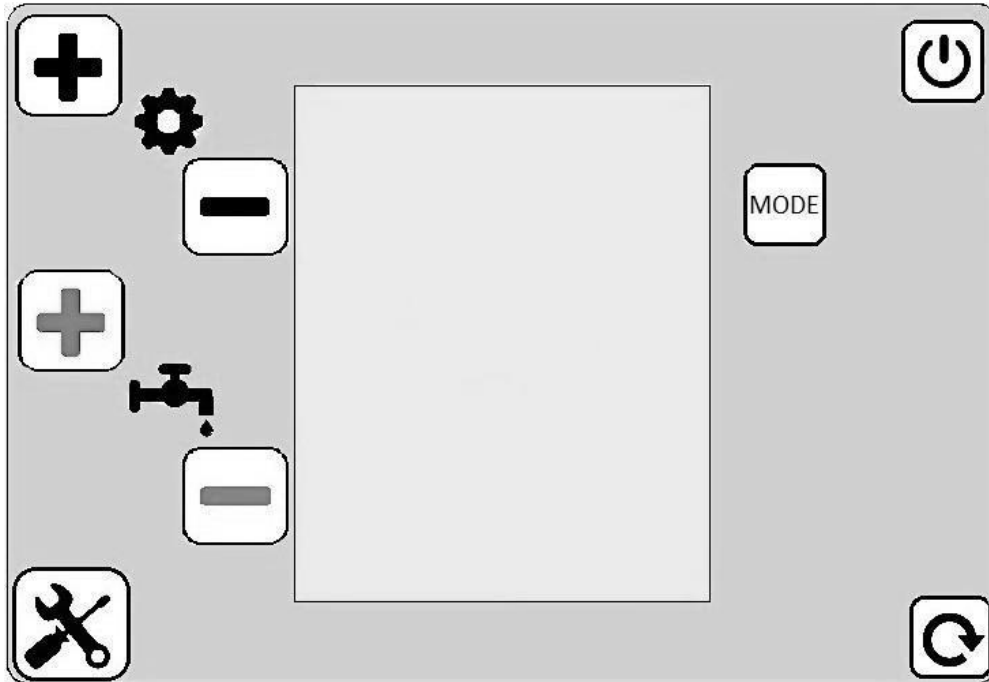

	On / Off (press for 2 seconds)		Exit from the information menu Exit from the password menu Exit from the parameter menu Exit from the chimney sweep mode Starting high chimney sweeper (press for 5 seconds)
	+ Flow set-point + 2nd password digit + Parameter Index		Information menu + Information Password confirmation parameters storing
	- Flow set-point - 2nd password digit - Parameter Index		boiler release
	+ 1st password digit + Parameter value + Information Maximum output operation		Login Menu / Parameters Password
	- 1st password Digit - Parameter value - Information Minimum output operation		

### 13. SAFETY AND INSTALLATION LOCAL REGULATIONS

**LOCAL REGULATIONS**

The installation must be in accordance with the local regulations established by:

- △ Fire fighters
- △ Gas Supply Company
- △ Power Supply Company
- △ Hygiene and Health Office

**SAFETY REGULATIONS**

- Do not perform any cleaning or maintenance work without having turned off the water heater and cut-off the power.
- Operating the water heater with disassembled protections of the electrical parts or with excluded safety devices is absolutely forbidden. Removing or tampering the safety devices is absolutely forbidden.
- In case of failure and / or malfunction, switch off the appliance, close the gas cock and do not try to repair it, but contact an authorized service centre.
- In case of fire, use powder fire extinguishers only, do not direct jets of water directly against the heater as this may cause short circuits.
- Use suitable manual or electrical tools and / or equipment: make sure that they are not worn out and that they are used properly.
- Make sure that ladders and / or rolling ladders are firmly positioned, that they are appropriate and that the steps are intact and not slippery, that they are not moved while someone is climbing them and that someone provides supervision at all times.

**INSTALLATION INSTRUCTIONS**

- During installation or servicing carried out at a certain height (generally with a difference in height of more than 2 meters), use rolling towers compliant with legal standards and make sure that the space below is free because tools and objects may fall.
- Make sure that, while installing and servicing the appliance, the workplace has suitable hygiene conditions in terms of lighting, ventilation and solidity of the structures.
- Wear individual protective clothing and equipment while installing and servicing the appliance.
- Do not take any action without a prior check of the absence of gas leaks by using a special detector.
- The installer must be qualified in the installation of heating equipment according to the law n. 46 of 05/05/1990 and, at the end, he has to issue the CONFORMITY DECLARATION to the customer.
- The appliance should be connected to a sanitary hot water distribution network that must be compatible with its performance and power levels. Make sure that the installation site and any systems to which the appliance must be connect comply with the regulations in force.
- Being a C-type unit, the appliance can be installed in any kind of place, without any restriction to its ventilation condition and volume.
- Before any installation, maintenance or repairing intervention, cut off the power supply to the unit. Protect all connection pipes and wires in order to prevent them from being damaged.
- The device has to be installed on the floor, leaving a suitable distance from the side walls to allow the gas and water connections, as well as any possible maintenance intervention. Furthermore, the appliance must be installed on a solid well-finished flat floor, that is not subject to vibration.
- Reseal the openings used to make the readings of CO<sup>2</sup> values at the maximum and minimum power.
- All operations inside the appliance must be performed with the necessary caution in order to avoid abrupt contact with sharp parts.
- Do not take any action without a prior check of the absence of an open flame or ignition sources.
- In case you detect a smell of burning or smoke coming from the appliance or a strong smell of gas, disconnect the appliance from the electrical supply, turn off the main gas valve, open all windows and contact the nearest authorized assistance service.

**IN ANY SITUATION, COMMON SENSE IS THE BEST SAFETY AGAINST ANY DAMAGE AND / OR INJURY.**

## 14. INSTALLATION

### OPERATION TO BE CARRIED OUT BY A QUALIFIED PERSON ONLY

Warning! The installation of the residential ventilation system must be performed by a qualified person only, in order to avoid damage or injury.

Before installing the appliance, check that the nominal supply voltage is 220 / 240V - 50Hz.

- Make sure that the electrical system is suitable to supply, in addition to the operating power required by the unit, also the necessary power for powering the appliances and equipment already in use.
- perform the electrical connections in accordance with national laws and regulations.
- Foresee an omnipolar switch with a minimum contacts distance of 3.5 mm upstream the unit.

The installation of the device is divided into 5 distinct phases, which are listed below, and which have to be followed respecting the order.

1. positioning the appliance
2. Flue system
3. Water supply connections
4. Gas supply connection
5. Electrical supply connections

The appliance needs to be earthed. Check that the electrical supply cable is in perfect condition. Under no circumstances repair the damaged cable with insulating tape or clips. If the power cord is damaged, it must be replaced by service person or by a similarly qualified person in order to avoid any hazard.

Improper installation may harm people, animals and possessions: the manufacturer shall not be held responsible for any damage caused as a result.

## 15. POSITIONING THE APPLIANCE

The location of the appliance must be chosen according to the maximum length allowed for each type of flue system, gas and electrical connection. The appliance is designed to have water, gas and electrical connections on the right side of the appliance, whereas the flue gas outlet is on the top of the appliance. It is recommended to place the heater in such a way as to facilitate the installation and maintenance operations.

The appliance, being a C-type unit, can be installed in any kind of place, without any restriction to its ventilation condition and volume.

The minimum acceptable clearances are shown below.

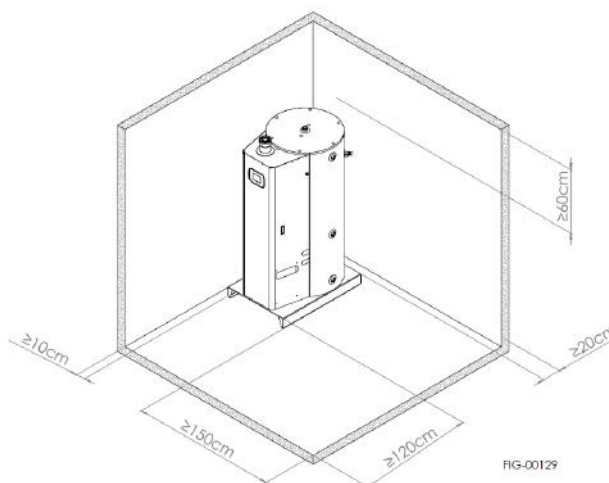

The front and right side of the appliance must be easily accessible, in order to facilitate proper installation and periodic maintenance.

To prevent possible infiltration of water during a thunderstorm, we recommend a slight downward slope of the flue and air duct.

**IMPORTANT: INSTALL IN ACCORDANCE WITH THE REQUIREMENTS OF NATIONAL INSTALLATION REGULATIONS**

## 16. FLUE SYSTEM

The appliance is a watertight premixed condensing boiler with fan upstream of the combustion chamber, equipped with a storage tank on the back. The low temperature of the exhaust flues allows the use of plastic flue systems. The installation of the flue systems must comply with local regulations in force.

The installation must comply also with municipal, provincial or sectoral regulations. Conveying the flue gases of more boilers within the same flue duct is not allowed: each boiler must have its own separate exhaust duct.

The water heater is factory supplied without flue kit. All the flue kits available for this unit are listed in the following chart. Use only the original kits (to be purchased separately depending on the type of exhaust system chosen) provided by the manufacturer.

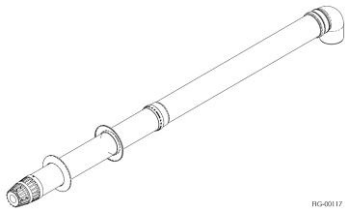
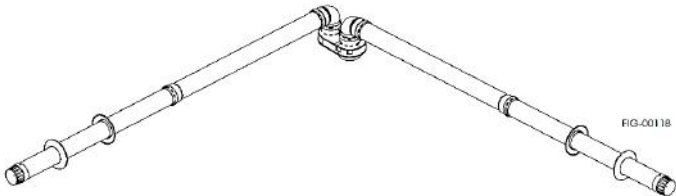
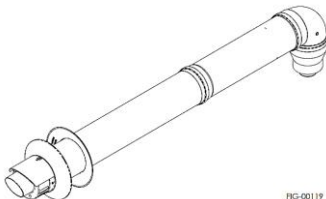
FLUE KIT	DESCRIPTION	
AKIT11 <i>Ø60 / 100 horizontal</i>		Length: 1.85m Height: 0.2m ↔ Minimum length: 1.5m Maximum length: 10m
AKIT12 <i>Ø80 / 80 horizontal</i>		Length: 2.1m Height: 0.3m ↔ Minimum length: 1m + 1m Maximum length: 30m + 30m
AKIT13 <i>Ø80 / 125 horizontal</i>		Length: 1,4m Height 0.3m ↔ Minimum length: 1.5m Maximum length: 26m

It is necessary to purchase special extensions (see the chart here below) to increase the flue length. The maximum allowed extension is shown in the chart above. For each additional 90° elbow 1 meter must be subtracted from the total flue length. The choice of a flue option rather than the other has to take into account local regulations, as well as technical considerations.

FLUE KIT	DESCRIPTION	REF.
AKIT11 <i>Ø60 / 100 horizontal</i>	Ø60 / 100 L = 500 coaxial extension	AKIT11-01
	Ø60 / 100 L = 1000 coaxial extension	AKIT11-02
	Ø60 / 100 L = 2000 Coaxial extension	AKIT11-03
	Ø60 / 100 45° Coaxial bend	AKIT11-04
	Ø60 / 100 90° Coaxial bend	AKIT11-05
AKIT12 <i>Ø80 / 80 twin pipe horizontal</i>	Ø80 L = 250 Extension	AKIT12-01
	Ø80 L = 500 Extension	AKIT12-02
	Ø80 L = 1000 Extension	AKIT12-03
	Ø80 L = 2000 Extension	AKIT12-04
	Ø80 45° bend	AKIT12-05
	Ø80 90° bend	AKIT12-06
AKIT13 <i>Ø80 / 125 horizontal</i>	Ø80 / 125 L = 500 coaxial extension	AKIT13-01
	Ø80 / 125 L = 1000 coaxial extension	AKIT13-02
	Ø80 / 125 L = 2000 coaxial extension	AKIT13-03
	Ø80 / 125 45° Coaxial bend	AKIT13-04
	Ø80 / 125 90° Coaxial bend	AKIT13-05

The mechanical stability of the air / flue duct has to be granted

The hole for passing the exhaust and the air intake pipe through the wall should not be blocked and the flue pipe must be free to slide through the hole in such a way that it can subsequently be detached. You can use the wall covers supplied with the flue kits to cover the empty space of the hole.

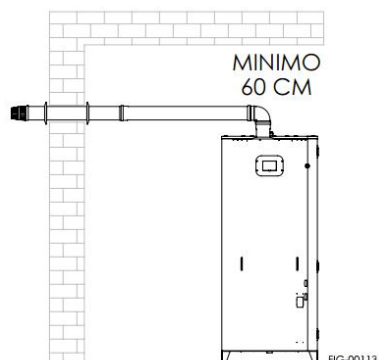

**IMPORTANT: LEAVE A CLEARANCE OF NO LESS THAN 60 CM ABOVE THE APPLIANCE TO ALLOW ANY MAINTENANCE TO THE TOP OF THE UNIT.**

### CONNECTION TO THE BOILER



The unit is factory supplied with a  $\varnothing 60 / 100$  polypropylene flue connection, provided with air and flue sampling.

The flue connection is not installed: it is packed together with the unit and positioned at the bottom of it, ready for installation.

**IMPORTANT: MAKE SURE YOU HAVE THE SAMPLING PLUGS FACING THE LEFT SIDE OF THE UNIT, TO ENSURE A PRACTICAL USE OF THEM. A WRONG POSITIONING CAN MAKE THE FLUE ANALYSIS DIFFICULT.**

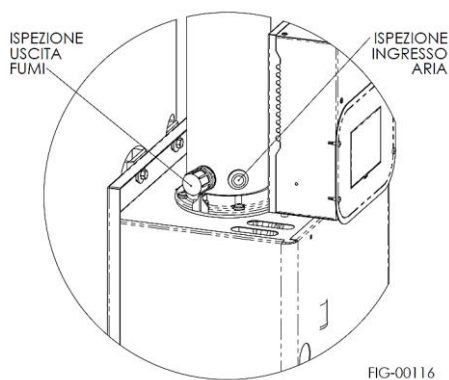

## 17. WATER CONNECTION

The appliance will last longer if the following parameters are met (as provided by the D. LGS. nr 31 February 2<sup>nd</sup> 2001, which is an implementation of EC Directive 98/83/CE on the quality of water intended for human consumption):

1. **Total hardness:** between 10 ° F and 25 ° F
2. **pH:** between 6 and 8
3. **Conductivity:** max. 2500 µS / cm

The appliance is protected against corrosion by a magnesium anode that must be replaced at least once every 12 months otherwise the warranty will be invalidated.

IMPORTANT: IF THE QUALITY OF WATER IS NOT WITHIN THE ABOVE PARAMETERS, PARTICULAR CARE SHOULD BE TAKEN IN THE PERIODIC MAINTENANCE OF THE TANK. THE REPLACEMENT OF THE MAGNESIUM ANODE MORE THAN ONCE A YEAR WILL BE COMPULSORY.

### HYDRAULIC COMPONENTS TO BE INSTALLED (NOT INCLUDED)

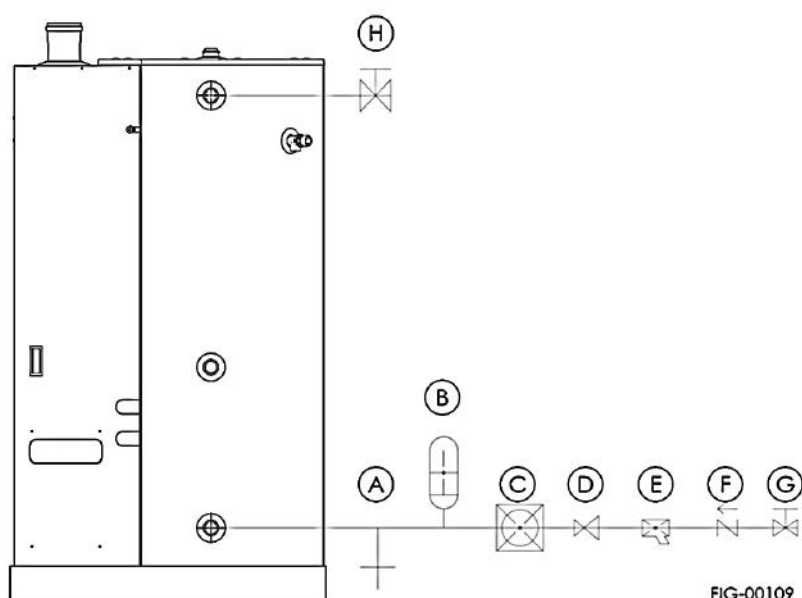

- A. T drain tap
- B. Expansion vessel, the capacity of which has not to be less than 5% of the capacity of the appliance.
- C. Softener, in case of particularly hard water (compulsory above 25 ° F).
- D. Pressure reducer (in case of water inlet pressure  $\geq 6$  kPa).
- E. Filter to remove water impurities.
- F. Check valve
- G. Shut-off valve
- H. Shut-off valve

### CONDENSATE DRAIN

Apply a flexible hose to the outlet of the siphon condensate discharge, in order to channel the condensate liquid.

### SAFETY VALVE

It discharges the water from the tank in case the internal pressure of the tank exceeds  $6.5 \pm 0.5$  bar. The valve is factory sealed and its tampering is forbidden, otherwise the warranty on the appliance will be invalidated. In the event the valve discharges water, it will be necessary to reduce the inlet pressure of water into the appliance.



## 18. GAS CONNECTION

Connect the gas supply line to the thread fitting of the appliance by means of a removable rigid connection: the gas pipe must exit through the slot of the appliance. The gas connection is G 3/4 " and it is covered by a red protection cap. It is recommended to foresee a gas interception manual tap near the appliance along the pipeline in an easily accessible position. See in the picture below, the gas connection and the slot for the tube passage.

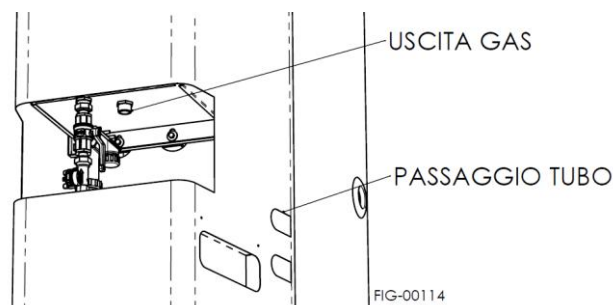

The device is delivered with the injector assembly set for G20 - 20 mbar gas (factory assembled with ref. 180-0026). In case of different gas such as G25 or G31, it will be necessary to purchase the related injector assembly (see the reference in the table here below).

### OTHER GAS TYPES



gas type	G20 - 20 mbar	G25 - 25 mbar	G31 - 37 mbar
Ref. for the injector assembly	180-0026	180-0027	180-0028

Check the whole gas pipeline for tightness and make sure that it was performed in accordance with the regulations in force on gas system (see SAFETY AND INSTALLATION LOCAL REGULATIONS).

## 19. ELECTRICAL CONNECTIONS

The appliance is supplied without mains plug: it must be mounted during the first installation.

Connect electrically to a 230V-50Hz single-phase power network and to an efficient earthing system. The connection has to be a polarized one. The appliance cable is composed of three cables having distinct colours: observe the table below to identify the correct polarization. PHASE LINE AND NEUTRAL OF THE PLUG must correspond to the PHASE LINE AND NEUTRAL OF THE ELECTRICAL OUTLET.

Grounding	Neutral	Phase line
		
green yellow	blue	Brown

Foresee near the appliance a bipolar switch in case of need to fully stop the appliance. Connect the power cable of the appliance, taking care to comply with the electrical standards of the country in which the appliance is installed. In case of replacement of the power cable, use a cable with the same specification (cable H05 VV-F - 3x0.75).

Warning: the device is not protected against the effects caused by lightning. Before performing any work on the electrical components of the appliance, first disconnect it from the electrical power supply using the bipolar switch.



THE INSTALLATION IS COMPLETED AND THE APPLIANCE IS READY TO BE TURNED ON AND ADJUSTED

## 20. STARTING AND TEMPERATURE ADJUSTMENT

### TURN ON AND TURN OFF

The system is powered and it's on OFF mode, on display control is visualized  symbol, the starting burner and all devices are inhibited.

By keeping the  key for 3 seconds the system switch to ON mode, display control is illuminated and are visualized the following devices:

- The temperature of the boiler probe is always shown in the upper part of the screen.
- The outgoing probe temperature is displayed at the bottom right.
- If the burner is fired and the flame is detected, the  symbol is displayed, boiler heating: the  symbol is displayed.
- The  modulation bar will indicate the percentage of the current burner output.





In case of anomalies in the system will appear on the display: "Err." and the error code "Fxxx" will flash alternately at the bottom right, where "xxx" is the specific error number. To this regard, see the "Faults" section for a complete list of system faults.

Chimney sweep: "St L" will be displayed at the bottom right, if the chimney sweep is activated at the minimum power, while "St H" will be displayed when the chimney sweep is activated at the maximum power.



To turn off the system is necessary to keep hold for 3 seconds the  key, then the system will turn off.



### TEMPERATURE ADJUSTMENT

By pressing the buttons  or  of  the boiler set-point is displayed and / or modified. After 5 seconds from the last editing or set-point viewing, the board goes back to the main screen, displaying at first the "-" symbol and then saving all the changes done. It is also possible to go back to the "stand-by" screen by pressing the  button.

### INFORMATION SCREEN

"InFO" is displayed by pressing the <sup>MODE</sup> button from the main screen, then you enter the information screen: it displays the information related to all the devices connected to the boiler. Once you enter the information screen, press again the <sup>MODE</sup> button or the key  of  to display the following information; press once the  key to display the previous information.

Information is cyclical, so that when all of them have been displayed, you go back to the first one. Press the  button to exit the information screen: the "-" symbol is displayed for one second, then you return to the main screen. If you stay in the information screen for ten consecutive minutes without pressing any key, the system returns to the main screen. It should be noted that when scrolling through the different devices, its corresponding symbol will flash in case one of them is faulty (in addition to the previously described error warning on the main screen).

- Outgoing probe temperature:

Writing at the bottom: "ch"

Device Symbol: 

- Return probe temperature:

Writing at the bottom: "rt"

Device Symbol: 

- Tank top probe temperature:

Writing at the bottom, "dh1"

Device Symbol: 

- Tank bottom probe temperature:

Writing at the bottom, "dh2"

Device Symbol: 

- Flue probe temperature:

Writing at the bottom: "cP"

Device Symbol: 

- Current fan speed:

Writing at the bottom: "FAN" when the fan is at rest

"set-point" speed when the fan is operating

Device Symbol: 

- Water flow rate:

Writing at the bottom: "FLO"

Device Symbol: 

- Safety thermostat (safety probe):

Writing at the top: "OPEn" if the probe temperature is higher than the limit of 105 ° C

"CLOS" if the probe temperature is lower than the limit of 105 ° C

Writing at the bottom: "SAFt"

Device Symbol: 

- Flame:

Writing at the top: "OFF" if the flame at the burner is not detected

"On" if the flame at the burner is detected

Writing at the bottom: "FLA"

Device Symbol: 

- Current operation percentage of the pump:

Writing at the bottom: "PUMP"

Device Symbol:  (with flashing arrows to indicate the water circulation)

- Igniter:

Writing at the top: "OFF" if the igniter is off

"On" if the igniter is operating

Writing at the bottom: "SPAR"

Device Symbol: 

- Gas valve:

Writing at the top: "OFF" if the valve is closed (not powered)

"On" if the valve is open (powered)

Writing at the bottom: "GAS"

Device Symbol: 

- Loads:

This information summarizes the current loads status, displaying the symbols (as described above) of the currently active devices in the system. Furthermore:

Writing at the top: current fan speed (in revolutions / minute).

Writing at the bottom: percentage of current pump speed

## 21. GAS SETTING AND CHANGING OF GAS TYPE

### CONVERSION OF GAS TYPE

To convert the appliance to another gas type it is necessary to replace the injector assembly with the one specially conceived for the gas type supplied by the gas pipeline. Then set the gas value on the control display (see "Gas value menu" in the table below), from menu 01 parameter 26.

Gas Type	Gas Value menu	CO <sub>2</sub> values
G20 - 20 mbar	1	9.2% max / min 9.2%
G25 - 25 mbar	3	9.0% max / min 9.0%
G31 - 37 mbar	2	11.2% max / min 11.1%



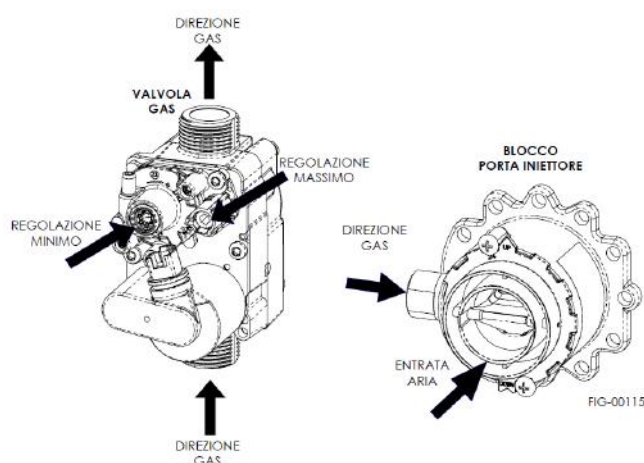

1. Replace the injector assembly with the one of the gas to be used
2. Set the correct gas value on the display menu: at menu 01, parameter 26, from 1 to 3 you have the gas value according to the gas type to be set (see gas value in the table above).
3. Adjust the gas valve to the correct CO<sub>2</sub> values at the maximum and minimum output.



### READING AND ADJUSTING THE CO<sub>2</sub> VALUE AT MAXIMUM OUTPUT

- Press the  button for at least 4 seconds. In this way, the chimney sweep function will be activated at maximum output ("St H" will appear on the display).
- Detect the CO<sub>2</sub> value at the analyzer, through the flue inspection plug on the coaxial pipe.
- If this value does not correspond to the correct one given in the table, it is necessary to adjust the screw of the maximum value in order to obtain the indicated value.
- Turn the screw counterclockwise to increase the value of CO<sub>2</sub> % and clockwise to reduce it.

### READING AND ADJUSTING THE CO<sub>2</sub> VALUE AT MINIMUM OUTPUT

- With the "chimney sweep" function already active, press the button  of  without exiting the sweep mode: in this way, the boiler is forced to the minimum power.
- Detect the CO<sub>2</sub> value at the analyzer, through the flue inspection plug on the coaxial pipe.
- If this value does not correspond to the correct one given in the table, it is necessary to adjust the screw of the minimum value in order to obtain the indicated value.
- Turn the screw clockwise to increase the value of CO<sub>2</sub> % and counterclockwise to reduce it.
- Return to the maximum power through the key , to verify that the adjustment of CO<sub>2</sub> at the minimum output did not affect the maximum one.
- Press  to exit the chimney sweep mode.

At the first ignition it is necessary to check the CO<sub>2</sub> values at the flue gas outlet (the correct values are given in the table above): If the CO<sub>2</sub> value (%) read differs from the values given in the table, it is necessary to adjust the gas valve by means of the screws of the maximum and minimum power, which are placed on the gas valve. In case of conversion to another gas type and / or change of the flue / air ducts, it is necessary to repeat the adjustment of the CO<sub>2</sub> values for the new type of plant.

THE GAS VALVE CAN BE ADJUSTED THROUGH THE SPECIAL HOLE, See picture below:

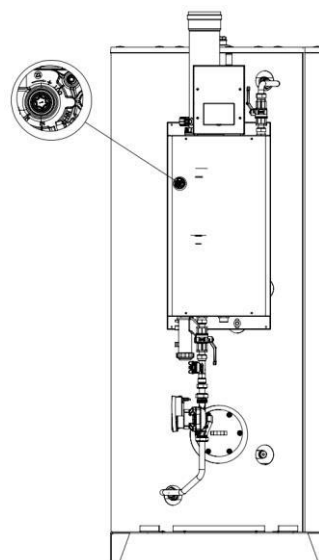

FIG-00140

Verify that the flue exhaust and air intake ducts are free from obstructions. A reduction of the air flow, due to an accidental obstruction of the air or flue duct, will result in a reduction in the gas flow till the turning off of the burner, in favour of a safe use.

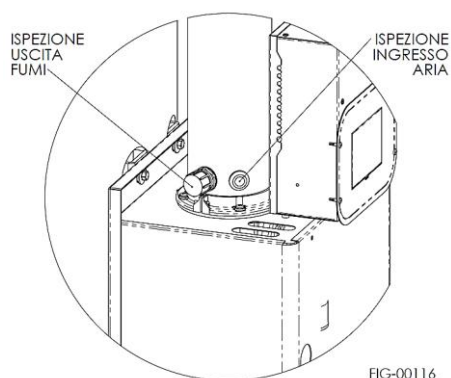



FIG-00116

To check the correct combustion, it is necessary to make an analysis using an appropriate flue gas analyzer (the same that is used to measure the combustion in accordance with the UNI 10389 standard). It is necessary to set the analyzer according to the CO<sub>2</sub> volumetric percentage of the type of gas used.











Use the suitable inspection plugs placed on the coaxial flue adapter, to adjust the gas valve.

**MENU PARAMETERS SCREEN**











**Password entry**

By pressing simultaneously the buttons <sup>MODE</sup> and  from the main screen (or even from the "off" screen), you access the password entry screen for the parameters menu. The system has two different passwords:

- one to access the parameters menu 01 "Installer" (default = "00"), for the user and installer;
- one to access the parameters menu 02 "Settings" (default = "05"), reserved to the installer;

The followings will be shown on the display: in the upper part, a two-digit password to be entered, at the bottom the word "PASS" and in the middle the  symbol. By pressing  of  the most significant digit of the password will be increased, by pressing  of  it will be decreased; by pressing  of  the least significant digit of the password will be increased, by pressing  of  it will be decreased. Press the <sup>MODE</sup> button to confirm the code: at this stage, if the password is correct, you will enter the specific parameters menu, otherwise, after the displaying of the symbol "- -", you will return to the main screen. Just press the  button to exit the password menu: the symbol "- -" is displayed for one second, after which you return to the main screen. If you stay in the password menu for ten consecutive minutes without pressing any key, the system returns to the main screen.

**PARAMETERS MENU**

The display of each parameters menu (installer menu, settings menu, factory menu) is the same: the current parameter value is displayed in the upper part, the index parameter at the bottom, in the middle the  symbol if you display the "Installer" menu, the  symbol if the "Settings" or "Factory" menu is displayed. You can scroll cyclically all the menu parameters by pressing the buttons  of  (index increase) or  of  (index decrease); you can advance rapidly in the index by keeping these keys pressed. Once the desired parameter is identified (refer to the following tables), it is possible to change the value by pressing the keys  of  (value increase) or  of  (value decrease); in this case too, it is possible to change quickly the values by holding the button pressed. Press the <sup>MODE</sup> button to save the newly modified parameter value: the message "MEMO" will be displayed and this will confirm the data saving. It is important to note that this operation will save only the value of the parameter currently displayed on the screen. In order to save multiple parameters, it is necessary to change the value parameter by parameter, and then press the <sup>MODE</sup> button. To exit any of the parameters menu, simply press the  button: the symbol "- -" is displayed for one second and then you return to the main menu. If you stay in a parameter menu for ten consecutive minutes without pressing any key, the system returns to the main menu.

TO THIS REGARD, IT IS VERY IMPORTANT TO NOTE THAT IF YOU EXIT A MENU PARAMETERS WITHOUT HAVING RECORDED THE NEW VALUES, ALL THE CHANGES WILL BE LOST AND THE PARAMETERS WILL RETURN TO THE VALUE SET BEFORE THE MODIFICATION.

**22. MENU PARAMETERS AND DESCRIPTION****MENU 01 - "INSTALLER" FOR THE USER AND INSTALLER**

<b>Index</b>	<b>Description</b>	<b>Default</b>	<b>Range</b>	<b>Unit of measurement</b>
01	Minimum percentage of circulator operation	19	[5-100]	%
02	Time-out for operation in the antilegionella mode	20	[0-240]	Minutes
03	"Antifreeze" function - NOT AVAILABLE	0	[0-2]	
04	Maximum fan speed	5600	[500 - 7500]	rpm
05	Minimum fan speed	2840	[500 - 5000]	rpm
06	Ignition speed	4500	[500 - 7500]	rpm
07	Inter-ventilation speed	3500	[500 - 7500]	rpm
08	Post-ventilation speed	4500	[500 - 7500]	rpm
09	Post-ventilation time	15	[0-240]	Seconds
10	Post-circulation time	6	[0-240]	Seconds
11	Maximum percentage of circulator operation	100	[30-100]	%
12	Solar system configuration - NOT AVAILABLE	0	[0-1]	-
13	Solar system set-point - NOT AVAILABLE	85	[30-90]	° C
14	Solar circulator Type n. ° 1 - NOT AVAILABLE	1	[1-2]	-
15	Minimum percentage of solar pump operation n. ° 1 - NOT AVAILABLE	50	[30-100]	%
16	Delta-on temperature of solar pump n. ° 1 - NOT AVAILABLE	6	[1-20]	° C
17	Delta-off temperature of solar pump n. ° 1 - NOT AVAILABLE	4	[1-20]	° C
18	Delta-modulation of solar pump n. ° 1 - NOT AVAILABLE	0	[1-30]	° C
19	Increase of solar circulator n. ° 1 - NOT AVAILABLE	1	[1-20]	-
20	Step for solar pump n. ° 1 - NOT AVAILABLE	1	[1-10]	-
21	Temperature limit for solar probes on solar panel - NOT AVAILABLE	180	[10-250]	° C
22	Temperature limit for solar probes on storage - NOT AVAILABLE	95	[10-100]	° C
23	"Solar Antifreeze" function - NOT AVAILABLE	0	[0-1]	-
24	Reset parameters	0	[0-1]	-
25	Operation type	1	[1-2]	-
26	Gas type	1	[1-3]	-

## MENU 02 - "SETTINGS" RESERVED TO THE INSTALLER

Index	Description	Default	Range	Unit of measurement
01	$\Delta T$ (+ temperature offset) respect to storage set-point for the burner turning off	0	[0-5]	° C
02	$\Delta T$ (- temperature offset) respect to storage set-point for the burner ignition	3	[1 - 15]	° C
03	$\Delta T$ (+ temperature offset) respect to the outgoing set-point for the burner turning off	5	[1-5]	° C
04	$\Delta T$ (- temperature offset) respect to the outgoing set-point for the burner ignition	4	[1-5]	° C
05	Maximum value for storage set point	60	[55-65]	° C
06	Minimum value for storage set point	40	[40-50]	° C
07	Outgoing storage set-point (+ offset respect to the storage set-point).	3	[0-5]	° C
08	Limit temperature for the tank sensor	85	[65-85]	° C
09	Limit Temperature for the flue gas probe	100	[80-110]	° C
10	Maximum increase at the outgoing probe	8	[4-16]	° C
11	Increase range for outgoing probe	2	[1-5]	Seconds
12	Control limit at outgoing probe increase	60	[40-80]	° C
13	LCD backlighting	1	[0-2]	-
14	Circulator modulation Offset "+"	4	[0-10]	%
15	Circulator modulation Offset "-"	(-) 4	[0 - (-) 10]	%
16	Update time pump modulation offset	1	[0-2]	Seconds



## **23.ANTILEGIONELLA FUNCTION**

Legionella is a bacterium that affects the respiratory system. Prevention of this infection is based on the correct one design and construction of hydro-sanitary systems.

The anti-legionella operating status allows to heat the water in the tank to prevent it from being inside proliferate the bacterium. To combat the infection on the entire building plant it is necessary to provide that the water treated by the WHC can circulate up to individual users.

The system brings the water to a temperature of 65 ° for 20 minutes. The LCD screen appears on the LCD control display written "LEg".

### **ACTIVATION**

#### **Antilegionella 3h:**

It activates as "Antilegionella 3h" three hours after the first time the system has been powered electrically and switched on or after a period of inactivity disconnected from the electrical system, in the meantime no request has been served the water of the tank at a temperature higher than or equal to 65° C.

#### **Antilegionella 7 days:**

It is activated as "Antilegionella 7gg" 7 days from the moment in which the antilegionella 3h status was activated for the last time or 7gg antilegionella, in the meantime no request has been served that has brought the water of the tank to one temperature above or equal to 65° C.

## 24. ELECTRONIC BOARD AND WIRING

### MOTHERBOARD MI860

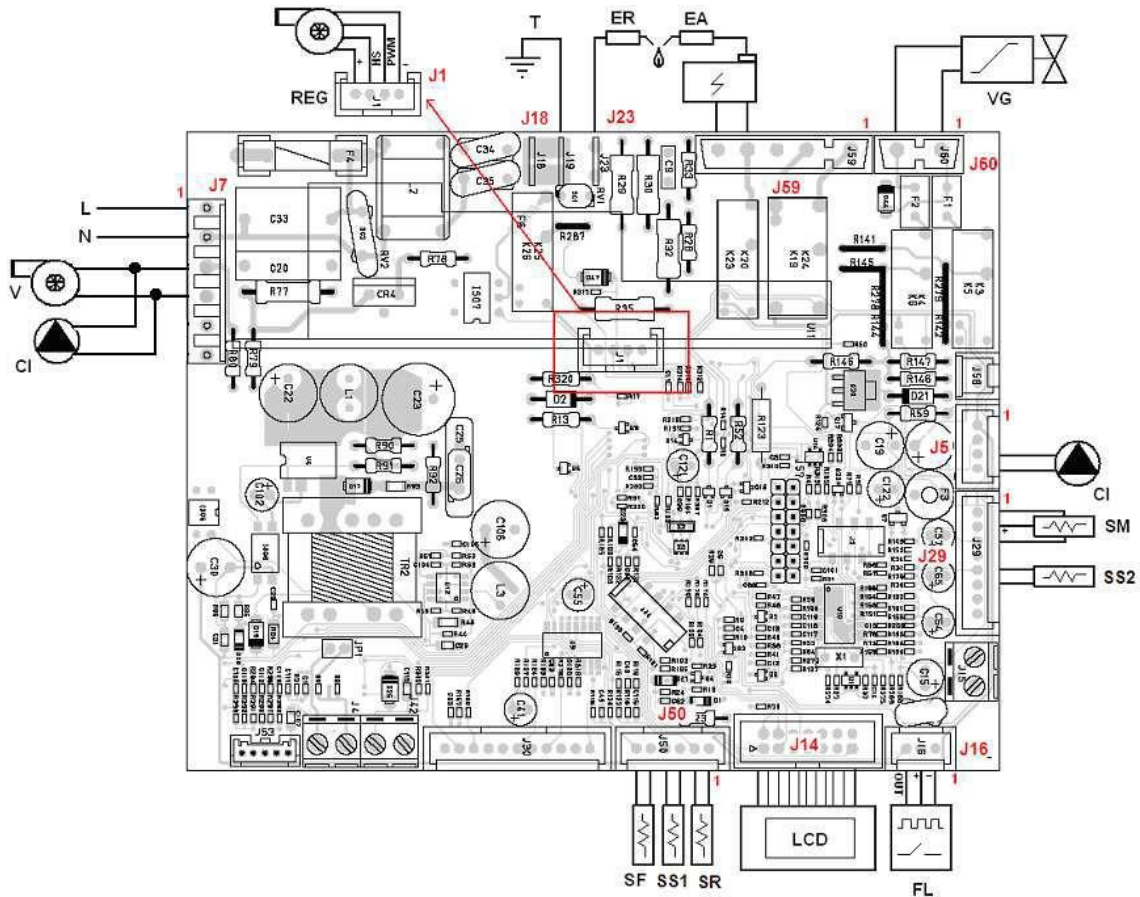

#### DESCRIPTION AND SPARE PARTS P/N

##### FUSE

3.15 A @ 250 VAC Rapid 5x20

##### Main power supply (L, N) 900-0095

Description: board main power supply

Contacts: J7 Connector

Type: Molex 6 poles

Pin: 1. L: Live (230 VAC, 50 Hz)

2. N: Neutral

Voltage: High (230 V<sub>AC</sub>)

##### Fan power supply (V) 900-0095

Description: Brushless fan supply with regulation electronics on board

Contacts: J7 Connector

210-0352\_libretto\_WH\_CATI\_eng.docx

Type: Molex 6 poles

Pin: 3. Live

4. Neutral

Voltage: High (230 V<sub>AC</sub>)

##### Circulation pump power supply (CI) 900-0095

Description: Boiler circulation pump power supply

Contacts: J7 Connector

Type: Molex 6 poles

Pin: 3. Live

4. Neutral

High voltage (230 V<sub>AC</sub>)

**Fan Driver (V-REG) 900-0096**

Description: Contacts for fan speed adjustment by PWM modulation and input signal coming from the Hall sensor.

Contacts: J1 Connector

Type: Lumberg 2,5 MSF 4 poles

- Pin:
1. + 24 V<sub>DC</sub>
  2. HS: Input Hall signal
  3. PWM: Output PWM signal
  4. -: GND

Voltage: Low (24 V<sub>DC</sub>)

**Pump PWM driver (CI-REG) 900-0127**

Description: Contacts for the regulation of modulating pump speed via PWM control signal.

Contacts: J5 Connector

Type: Lumberg 2,5 MSF 14 poles

- Pin:
3. PWM: Output PWM signal
  4. -: GND

Voltage: Low (24 V<sub>DC</sub>)

**Flowmeter (FLUX) 900-0106**

Description: water drawing signalling device.

Contacts: J16 Connector

Type: Lumberg 2.5 MSF 3 poles

- Pin:
1. -: GND
  2. +: 5 V<sub>DC</sub>
  3. OUT: Input Signal

Voltage: Low (V<sub>DC</sub>)

**Flame detection electrode (ER) 900-0094**

Description: Connection for flame detection electrode.

Contacts: J23 Connector

Type: Faston 4,8x0,8

Voltage: High (230 V<sub>AC</sub>)

**Igniter (AE) 900-0097**

Description: high efficiency electronics ignitor

Contacts: J59 Connector

Type: Stocko 5 poles

- Pin:
4. Live
  5. Neutral

Voltage: High (230 V<sub>AC</sub>)

**Primary outgoing water probe / safety (thermostat)probe (SM/TS) 900-0100**

Description: probe that measures the water temperature at the primary heat exchanger outlet. It also acts as a safety thermostat in order to make the system safe against possible overheating in the circuit.

Contacts: J29 Connector

Type: Lumberg 2.5 MSF 8 poles

- Pin:
1. Input signal
  2. +: 5 V<sub>DC</sub>
  3. Input signal

Voltage: Low (5 V<sub>DC</sub>)

**Flues sensor (SF) 900-0107**

Description: probe that measures the temperature of the flues produced by combustion.

Contacts: J50 Connector

Type: Lumberg 2.5 MSF 6-poles

- Pin:
5. GND
  6. Input signal

Voltage: Low (5 V<sub>DC</sub>)

**Boiler probe 1 (SS1) 900-0107**

Description: Probe that measures the water temperature of the boiler (at the bottom).

Contacts: J50 Connector

Type: Lumberg 2.5 MSF 6-poles

- Pin 3. GND
- 4. Input signal

Voltage: Low (5 V<sub>DC</sub>)

**Return probe (SR) 900-0107**

Description: Probe that measures the water temperature of the boiler (inlet).

Contacts: J50 Connector

Type: Lumberg 2.5 MSF 6-poles

- Pin: 1. GND
- 2. Input signal

Voltage: Low (5 V<sub>DC</sub>)

**Boiler probe 2 (SS2) 900-0100**

Description: Probe that measures the water temperature of the boiler (in the upper part).

Contacts: J29 Connector

Type: Lumberg 2.5 MSF 8-poles

- Pin: 5. 5 VDC
- 6. Input signal

Voltage: Low (5 V<sub>DC</sub>)

**Gas valve 230 VAC (VG) 900-0093**

Description: Gas valve (230 V<sub>AC</sub>) with pneumatic control of air-gas mixing.

Contacts: J60 Connector

Type: Stocko 2-poles

- Pin: 1. Neutral
- 2. Live

Voltage: High (230 V<sub>AC</sub>)

**Control board (LCD) 900-0101**

Description: Back-lighted LCD control board to display information and carry out any adjustment and setting with pushbuttons.

Contacts: J14 Connector

Type: tray connector 14-poles

Voltage: Low (5 V<sub>DC</sub>)

**Earthing 900-0104**

Description: Earth connection (functional) of the board.

Contacts: J18 Connector

Type: Faston 6.3x0.8

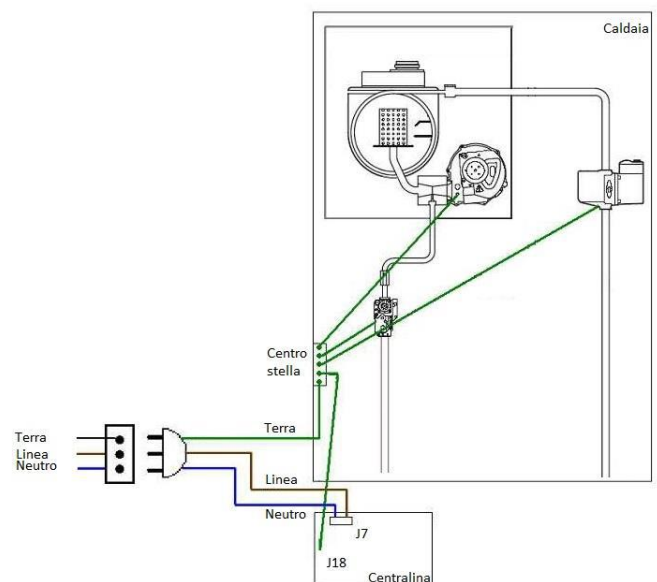

## 25. OTHER SYSTEM FEATURES

### POST-CIRCULATION

The boiler pump post-circulation function is useful to dissipate the water exceeding heat in the circuit after an operating phase with burner. It is performed when the following conditions are met:

1. Change from boiler heating mode to standby or off mode.
2. Change from chimney sweep mode (at minimum or maximum power) to the stand-by or off mode. This happens only if the pump is active and the burner ignited during the mode transition; otherwise, at the mode transition the circulation pump stops (or remains stationary).

### LOCKOUT PREVENTION

This feature is useful to prevent the lockout of the circulation pump after a prolonged period of inactivity. In particular, if 24 hours have passed without any pump activation and the board is in the stand-by status, the circulator will switch on for 5 seconds at the maximum speed.

### POST-VENTILATION

Following the turning off of the burner (for any reason, such as change of operating status, anomaly, overtemperature), it is possible to perform a post-ventilation cycle to ventilate the heat exchanger and discharge residual flues or unburned gas. The duration of the post-ventilation cycle and the fan speed can be set from parameter.

## 26. FAULTS

Any anomaly in the system operation is detected and displayed on the LCD control board. In particular, the message "Err." will appear at the bottom right corner alternately with the specific error code (or, if the system is affected by more than one anomaly at the same time, with the error code of the last detected anomaly). The notation for the error code is as follows: "Fxxx", where "xxx" indicates the anomaly code. For each anomaly the fault code is reported, as well as the description (with suggestions on what to do to solve the problem) and the system performance, particularly with regard to loads management.

In addition to reporting the error code, the LCD shows the



fault symbol and the symbol related to device in

failure. Whenever a fault occurs, the back-lighting of the display is activated for ten seconds, then it turns off.

## 27. SAFETY ANOMALIES

These anomalies relate to the operating cycle (safety) of the system, namely the ignition cycle and the presence / absence of flame in the burner when working up to speed.

### FAULT F020

#### DESCRIPTION



Lockout due to ignition failure.

#### ACTIVATION / DEACTIVATION CONDITIONS

- The anomaly occurs if there is a request for ignition and the system performs all attempts available, without being able to ignite the burner.
- The anomaly is deactivated, if you press and release the  reset button.

#### DISPLAYS

The message "Err." appears alternately with the message

"F020". The  flashing fault symbol and the  flashing lockout failure symbol are displayed.

#### DEVICES

Gas valve: Off.

Fan: a post-ventilation cycle is performed, if foreseen, then it is deactivated.

Circulation pump: Off.

### FAULT F022

#### DESCRIPTION



Parasitic flame.

#### ACTIVATION / DEACTIVATION CONDITIONS

- The anomaly occurs, if there is an ignition request and the system detects the presence of flame in the burner for two consecutive seconds before the safety time.
- The anomaly is deactivated, if the system detects no flame before the safety time.

## DISPLAYS

The message "Err." appears alternately with the message

"F022". The  flashing fault symbol and the  flashing flame failure symbol are displayed.

## DEVICES

Gas valve: Off.

Fan: it moves to the ignition speed and there remains, to be ready for ignition in the event that the anomaly is solved.

Circulation pump: Off.

## FAULT F023

### DESCRIPTION



Lockout for safety thermostat contact opening (safety probe temperature above the limit threshold).

### ACTIVATION / DEACTIVATION CONDITIONS

- The anomaly occurs if the double contact flow/safety probe detects a temperature equal to, or higher than 100 ° C
- The anomaly is deactivated if both of the following conditions occur:
  1. The double contact flow/safety probe detects a temperature lower than 100 ° C.
  2. You press and release the  reset button.

## DISPLAYS

The message "Err." appears alternately with the message

"F023". The  flashing fault symbol and the  flashing safety thermostat failure symbol are displayed.

## DEVICES

Gas valve: Off.

Fan: It remains active (or turns on) at the post-purge speed.

Circulation pump: turned on at the maximum mechanical speed.

## FAULT F025

### DESCRIPTION



Fan speed lower than the minimum safety threshold (with burner in full operation)

### ACTIVATION / DEACTIVATION CONDITIONS

- The anomaly occurs if the following conditions happen simultaneously:
  1. The burner is in full operation (flame present after the safety time).
  2. The fan speed falls below 300 revolutions / minute.
- The anomaly is deactivated when the fan speed rises above 400 revolutions / minute.

## DISPLAYS

The message "Err." appears alternately with the message

"F025". The  flashing fault symbol and the  flashing symbol of fan failure are displayed.

## DEVICES

Gas valve: Off.

Fan: If the request is still active, the system tries to bring the fan speed to the ignition speed to try a new burner ignition.

## FAULT F026

### DESCRIPTION

Lockout due to flow probe overheating.

### ACTIVATION / DEACTIVATION CONDITIONS

- The anomaly occurs if, within the time interval of one hour, the anomaly for flow sensor overheating is activated for three consecutive times (fault F032).
- The anomaly is deactivated if both of the following conditions occur:
  1. The probe temperature falls below the value indicated by the parameter "Menu 02.Parameter 12".
  2. You press and release the  reset button.

**DISPLAYS**

The message "Err." appears alternately with the message "F026". The  flashing fault symbol is displayed.

**DEVICES**

Gas valve: Off.

Fan: it turns on (or remains active) at the post-purge speed.

Circulation pump: Activated at maximum speed.

**FAULT F027**

**DESCRIPTION**

Lockout for flues probe overheating.

**ACTIVATION / DEACTIVATION CONDITIONS**

- The anomaly occurs if:  
Flue gas temperature probe \_ Menu 02.Parameter 09
- The anomaly is deactivated if both of the following conditions occur:
  1. The probe temperature falls below the value indicated by the parameter "menu 02.Parameter 09".
  2. You press and release the  reset button

**DISPLAYS**

The message "Err." appears alternately with the message "F027". The  flashing fault symbol is displayed.

**DEVICES**

Gas valve: Off.

Fan: it turns on (or remains active) at the post-purge speed.

Circulation pump: If a post-circulation cycle is foreseen, it is performed, then it turns off.

**FAULT F028**

**DESCRIPTION**

Abnormal communication between microcontrollers.

**ACTIVATION / DEACTIVATION CONDITIONS**

- The anomaly occurs, if the safety microcontroller and thermoregulation microprocessor are not communicating properly after 30 seconds.
- The anomaly is deactivated when communication resumes properly.

**DISPLAYS**

The message "Err." appears alternately with the message "F028". The  flashing fault symbol is displayed. The display of the flow probe temperature disappears and it is replaced by the "- -"symbol, as this probe is read by the safety microcontroller (and communicated to the thermoregulation microcontroller which takes care of its display on the LCD) and its value can no longer be trusted.

**DEVICES**

Gas valve: Off.

Fan: if foreseen, a post-purge cycle is performed, then it is deactivated.

Circulation pump: it performs a post-circulation cycle, if foreseen, then it turns off.

**FAULT F029**

**DESCRIPTION**

Lockout for gas valve blown protection fuse.

**ACTIVATION / DEACTIVATION CONDITIONS**

- The anomaly occurs if the fuse protecting the gas valve intervenes (blown fuse).
- The anomaly cannot be adjusted

**DISPLAYS**

The message "Err." appears alternately with the message "F029". The  flashing fault symbol is displayed.

**DEVICES**

Gas valve: Off.

Fan: if foreseen, a post-purge cycle is performed, then it is deactivated.

Circulation pump: it performs a post-circulation cycle, if foreseen, then it turns off.

**FAULT F059**

**DESCRIPTION**



Lockout for rapid increase at the flow probe temperature

**ACTIVATION / DEACTIVATION CONDITIONS**

- This anomaly happens, if the F058 anomaly occurs twice in 10 minutes or for 3 times in 120 minutes.
- The anomaly is deactivated if the  reset button is pressed and released.

**DISPLAYS**

The message "Err." appears alternately with the message

"F059". The  flashing fault symbol and the  flashing symbol for temperature anomaly are displayed.

**DEVICES**

Gas valve: Off.

Fan: if foreseen, a post-purge cycle is performed, then it is deactivated.

Circulation pump: Activated at maximum speed.

**FAULT F090**

**DESCRIPTION**

Lockout for generic anomaly on the safety microcontroller circuitry.

**ACTIVATION / DEACTIVATION CONDITIONS**

- This anomaly happens, if a generic hardware or software anomaly occurs (not contemplated in the main cases taken into consideration in this document) on any of the components that makes up the safety microcontroller circuitry.
- The anomaly is deactivated if you press and

release the  reset button.

**DISPLAYS**

The message "Err." appears alternately with the message

"F090". The  flashing fault symbol is displayed.

**DEVICES**

Gas valve: Off.

Fan: if foreseen, a post-purge cycle is performed, then it is deactivated.

Circulation pump: it performs a post-circulation cycle, if foreseen, then it turns off.

**FAULTS F091, F092, F093, F094, F095**

**DESCRIPTION**

Lockout for hardware failure on the safety microcontroller circuitry.

**ACTIVATION / DEACTIVATION CONDITIONS**

- These anomalies activate if a hardware failure occurs on any of the components that makes up the safety microcontroller circuitry.
- These anomalies are not restorable.

**DISPLAYS**

The message "Err." appears alternately with the message

(F090, F091, etc.). The  flashing fault symbol is displayed.

**DEVICES**

Gas valve: Off.

Fan: if foreseen, a post-purge cycle is performed, then it is deactivated.

Circulation pump: it performs a post-circulation cycle, if foreseen, then it turns off.

**FAULT F096**

**DESCRIPTION**

Date storing error EEPROM (thermoregulation microcontroller).

**ACTIVATION / DEACTIVATION CONDITIONS**

- This anomaly activates, if a data storing error occurs in one or more parameters by the thermoregulation microcontroller in its EEPROM memory. The EEPROM memory is used either to store the non-volatile system data (but not the safety ones), such as the current operating mode, the working set-point and all the parameters. For each data recorded in the EEPROM, the system performs a reading to verify the correctness of the operation performed. If the data read is not



congruent with the written one, the anomaly activates.

- This anomaly is deactivated if, in view of a new operation towards the EEPROM, the data is properly stored.

**DISPLAYS**

The message "Err." appears alternately with the message "F096". The  flashing fault symbol is displayed.

**DEVICES**

Gas valve: Off.

Fan: if foreseen, a post-purge cycle is performed, then it is deactivated.

Circulation pump: it performs a post-circulation cycle, if foreseen, then it turns off.

**FAULT F097**

**DESCRIPTION**



Discordant values for the two NTC sensors of the flow/safety probe.

**ACTIVATION / DEACTIVATION CONDITIONS**

- The anomaly occurs if the safety microcontroller detects discordant temperature values for the two NTC sensors of the dual flow/safety probe.
- The anomaly occurs if the safety microcontroller detects congruent temperature values for the two NTC sensors of the dual flow/safety probe.

**DISPLAYS**

"Err." appears alternating with the message "F097". The

 flashing fault symbol and the  flashing sensor fault symbol are displayed

**DEVICES**

Gas valve: Off.

Fan: if foreseen, a post-purge cycle is performed, then it is deactivated.

Circulation pump: it performs a post-circulation cycle, if foreseen, then it turns off.

**FAULT F098**

**DESCRIPTION**



Flow/safety double sensor interrupted or short-circuited → flow NTC

**ACTIVATION / DEACTIVATION CONDITIONS**

- The anomaly occurs if the safety microcontroller detects that the NTC of the flow / safety double sensor is interrupted or short-circuited.
- The anomaly is deactivated if the safety microcontroller detects that the NTC of the flow / safety double probe is no longer interrupted or short-circuited.

**DISPLAYS**

The message "Err." appears alternately with the message

"F098". The  flashing fault symbol and the  sensor fault flashing symbol are displayed.

**DEVICES**

Gas valve: Off.

Fan: if foreseen, a post-purge cycle is performed, then it is deactivated.

Circulation pump: it performs a post-circulation cycle, if foreseen, then it turns off.

**FAULT F099**

**DESCRIPTION**



Flow/safety double sensor interrupted or short-circuited → safety NTC.

**ACTIVATION / DEACTIVATION CONDITIONS**

- The anomaly occurs if the safety microcontroller detects that the NTC of the flow / safety double probe concerning the safety is interrupted or short-circuited.
- The anomaly is deactivated if the safety microcontroller detects that the NTC of the flow / safety double sensor related to safety is no longer interrupted or short-circuited.

**DISPLAYS**

"Err." appears alternating with the message "F099". The

 flashing fault symbol and the  flashing sensor fault symbol are displayed.

**DEVICES**

Gas valve: Off.

Fan: if foreseen, a post-purge cycle is performed, then it is deactivated.

Circulation pump: it performs a post-circulation cycle, if foreseen, then it turns off.

**28. PROBES FAULTS**

These anomalies relate to the temperature probes.

**FAULT F030**

**DESCRIPTION**



Interrupted flow sensor.

**ACTIVATION / DEACTIVATION CONDITIONS**

- The anomaly occurs if:  
resistive sensor value  $\geq 50 \text{ k}\Omega$
- The anomaly is deactivated if:  
resistive sensor value  $< 50 \text{ k}\Omega$

**DISPLAYS**

"Err." appears alternating with the message "F030". The

 flashing fault symbol and the  flashing sensor fault symbol are displayed.

**DEVICES**

Gas valve: Off.

Fan: if foreseen, a post-purge cycle is performed, then it is deactivated.

Circulation pump: it performs a post-circulation cycle, if foreseen, then it turns off.

**FAULT F031**

**DESCRIPTION**

Short-circuited low sensor

**ACTIVATION / DEACTIVATION CONDITIONS**



- The anomaly occurs if:

sensor resistive value  $\leq 400 \Omega$

- The anomaly is deactivated if:  
sensor resistive value  $> 400 \Omega$

**DISPLAYS**

"Err." appears alternating with the message "F031". The

 flashing fault symbol and the  flashing sensor fault symbol are displayed.

**DEVICES**

Gas valve: Off.

Fan: if foreseen, a post-purge cycle is performed, then it is deactivated.

Circulation pump: it performs a post-circulation cycle, if foreseen, then it turns off.

**FAULT F032**

**DESCRIPTION**



Flow sensor in overheating.

**ACTIVATION / DEACTIVATION CONDITIONS**

- The anomaly occurs if:  
Flow sensor temperature  $> 90 \text{ }^\circ\text{C}$
- The anomaly is deactivated if:  
Flow probe temperature  $< 89 \text{ }^\circ\text{C}$

**DISPLAYS**

"Err." appears alternating with the message "F032". The

 flashing fault symbol and the  flashing sensor fault symbol are displayed.

**DEVICES**

Gas valve: Off.

Fan: If the request is still active, the system brings the fan to the ignition speed in order to try a new burner ignition.

Circulation pump: Active and at the maximum mechanical speed.

**FAULT F033**

**DESCRIPTION**



Interrupted boiler probe.

**ACTIVATION / DEACTIVATION CONDITIONS**

- The anomaly occurs if:  
sensor resistive value  $\geq 47 \text{ k}\Omega$
- The anomaly is deactivated if:  
sensor resistive value  $< 47 \text{ k}\Omega$

#### DISPLAYS

"Err." appears alternating with the message "F033". The

 flashing fault symbol and the  flashing sensor fault symbol are displayed.

#### DEVICES

Gas valve: Off.

Fan: if foreseen, a post-purge cycle is performed, then it is deactivated.

Circulation pump: it performs a post-circulation cycle, if foreseen, then it turns off.

#### FAULT F034

##### DESCRIPTION



Short-circuited boiler probe.

##### ACTIVATION / DEACTIVATION CONDITIONS

- The anomaly occurs if:  
sensor resistive value  $\leq 400 \Omega$
- The anomaly is deactivated if:  
sensor resistive value  $> 400 \Omega$

#### DISPLAYS

"Err." appears alternating with the message "F034". The

 flashing fault symbol and the  flashing sensor fault symbol are displayed.

#### DEVICES

Gas valve: Off.

Fan: if foreseen, a post-purge cycle is performed, then it is deactivated.

Circulation pump: it performs a post-circulation cycle, if foreseen, then it turns off.

#### FAULT F035

##### DESCRIPTION



Overheated boiler probe.

##### ACTIVATION / DEACTIVATION CONDITIONS

- The anomaly occurs if:  
Flow probe temperature  $\geq$  Menu 02.Parameter 08
- The anomaly is deactivated if:  
Flow probe temperature  $<$  Menu 02.Parameter 08

#### DISPLAYS

"Err." appears alternating with the message "F035". The

 flashing fault symbol and the  flashing sensor fault symbol are displayed.

#### DEVICES

Gas valve: Off.

Fan: If the request is still active, the system brings the fan speed to the ignition speed to try a new burner ignition.

Circulation pump: Off.

#### FAULT F036

##### DESCRIPTION



Interrupted flues probe.

##### ACTIVATION / DEACTIVATION CONDITIONS

- The anomaly occurs if:  
probe resistive value  $\geq 80 \text{ k}\Omega$
- The anomaly is deactivated if:  
probe resistive value  $< 80 \text{ k}\Omega$

#### DISPLAYS

"Err." appears alternating with the message "F036". The

 flashing fault symbol and the  flashing sensor fault symbol are displayed.

#### DEVICES

Gas valve: Off.

Fan: if foreseen, a post-purge cycle is performed, then it is deactivated.

Circulation pump: it performs a post-circulation cycle, if foreseen, then it turns off.

**FAULT F037****DESCRIPTION**



Short-circuited flues probe

**ACTIVATION / DEACTIVATION CONDITIONS**

- The anomaly occurs if:  
sensor resistive value  $\leq 100 \Omega$
- The anomaly is deactivated if:  
sensor resistive value  $> 100 \Omega$

**DISPLAYS**

"Err." appears alternating with the message "F037". The

 flashing fault symbol and the  flashing sensor fault symbol are displayed.

**DEVICES**

Gas valve: Off.

Fan: if foreseen, a post-purge cycle is performed, then it is deactivated.

Circulation pump: it performs a post-circulation cycle, if foreseen, then it turns off.

**29. FAN FAULTS**

These anomalies involve the fan speed.

**FAULT F060****DESCRIPTION**



Failure at the fan Hall sensor.

**ACTIVATION / DEACTIVATION CONDITIONS**

- The anomaly occurs, if the board detects from the Hall sensor a number of impulses per second higher than, or equal to 500.
- The anomaly is deactivated if the board detects from the Hall sensor a number of impulses per second less than 500.

**DISPLAYS**

"Err." appears alternating with the message "F060". The

 flashing fault symbol and the  flashing symbol of fan failure are displayed.

**DEVICES**

Gas valve: Off.

Fan: If the demand is still active, the system tries to bring the fan to the ignition speed in order to try a new burner ignition.

**FAULT F061****DESCRIPTION**



Fan speed out of the expected range (instantaneous condition).

**ACTIVATION / DEACTIVATION CONDITIONS**

- The anomaly occurs if the fan reached the set-point of the expected speed but exits, even only instantly, the permissible range [set-point  $\pm 1000$  rev / min].
- The anomaly is deactivated if the fan goes back within the permissible range for the set-point [set-point  $\pm 1000$  rev / min].

**DISPLAYS**

"Err." appears alternating with the message "F061". The

 flashing fault symbol and the  flashing symbol of fan failure are displayed.

**DEVICES**

Gas valve: Off.

Fan: If the demand is still active, the system tries to bring the fan to the ignition speed in order to try a new burner ignition.

**FAULT F062****DESCRIPTION**



Fan speed out of the expected range (extended condition).

**ACTIVATION / DEACTIVATION CONDITIONS**

- The anomaly occurs if the fan does not reach the set-point in the range [set-point  $\pm 1500$  rev / min] for more than 30 consecutive seconds.
- The anomaly is deactivated if the fan enters the permissible range for set-point [set-point  $\pm 1500$  revolutions / minute].

**DISPLAYS**

"Err." appears alternating with the message "F062". The

 flashing fault symbol and the  flashing symbol of fan failure are displayed.

**DEVICES**

Gas valve: Off.

Fan: If the demand is still active, the system tries to bring the fan to the ignition speed in order to try a new burner ignition.

**FAULT F063****DESCRIPTION**



Fan speed out of the expected range (final condition).

**ACTIVATION / DEACTIVATION CONDITIONS**

- The anomaly occurs if the fan remains in the situation described by the previous anomaly 06.62 (speed outside range for a prolonged time) for more than 10 consecutive minutes.
- The anomaly is deactivated when you bring the card in OFF mode and then back to the ON mode, or if you cut-off and restore electrical power to the board.

**DISPLAYS**

"Err." appears alternating with the message "F063". The

 flashing fault symbol and the  flashing symbol of fan failure are displayed

**DEVICES**

Gas valve: Off.

Fan: Off.

Circulation pump: it performs a post-circulation cycle, if foreseen, then it turns off.

**FAULT F064****DESCRIPTION**



Fan not working.

**ACTIVATION / DEACTIVATION CONDITIONS**

- The anomaly occurs if the fan stops and does not reach, within 20 seconds, the speed set-point set by the system (within the range [set-point  $\pm$  1000 revolutions / minute]).
- The anomaly is deactivated if the fan reaches the speed set-point set by the system (within the range [set-point  $\pm$  1000 rev / min]).

**DISPLAYS**

Err." appears alternating with the message "F064". The

 flashing fault symbol and the  flashing symbol of fan failure are displayed.

**DEVICES**

Gas valve: Off.

Fan: If the demand is still active, the system tries to bring the fan to the ignition speed in order to try a new burner ignition.

## 30. FAULTS FLOW

Fan: Off.

These anomalies involve the flowmeter for measuring the water flow rate.

### FAULT F083

#### DESCRIPTION

Faulty flowmeter.

#### ACTIVATION / DEACTIVATION CONDITIONS

- The anomaly occurs if the board detects from the flowmeter a number of impulses per second higher than or equal to 500.
- The anomaly is deactivated if the boards detects from the flowmeter a number of impulses per second lower than 500.

#### DISPLAYS

"Err." appears alternating with the message "F083". The



flashing fault symbol is displayed.

#### DEVICES

Gas valve: Off.

Fan: Off.

### FAULT F084

#### DESCRIPTION

Insufficient water flow.

#### ACTIVATION / DEACTIVATION CONDITIONS

- The anomaly occurs if the circulation pump is active and the flow meter detects a water flow rate lower than 6.0 litres / minute.
- The anomaly is deactivated if the circulation pump is turned off or the flow meter detects a water flow rate higher than 6.0 litres / minute.

#### DISPLAYS

"Err." appears alternating with the message "F084". The



flashing fault symbol is displayed.

#### DEVICES

Gas valve: Off.

### **31.SERVICING THE HEAT EXCHANGER**

In case of particularly hard water, it is necessary to perform the cleaning of the exchanger periodically. This type of cleaning is performed by means of a 3-way valve installed in the appliance, used to circulate a descaling detergent. Use detergents suitable for limestone cleaning only, not aggressive towards materials such as steel, copper and brass. Follow the instructions below for a thorough cleaning.

**IMPORTANT:** The operation must be performed only by our authorized service centres.

1. Isolate the appliance electrically.
2. Close the shut-off valves installed in the circuit external to the device.
3. Unscrew the plugs from the 3-way valve assemblies as shown in the picture on the left.
4. Connect the appliance for the exchanger cleaning to the G 3/4 "connections instead of just removed caps.
5. Turn the lever 90 ° as shown in the picture below. In this way the flow is deviated in the indicated outlet.
6. Start the cleaning cycle for the necessary time.
7. At the end of the cleaning cycle, you must perform a thorough rinsing of the heat exchanger to remove any residual detergent used during the cleaning.
8. After the rinse cycle of the exchanger, close the 3-way valves with the caps removed earlier.
9. Return the levers 90 ° to the initial position.
10. Reopen the shut-off valves.
11. Make sure there are no leaks along the system.
12. Reconnect the appliance.

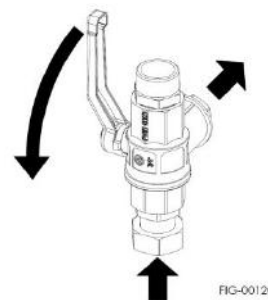
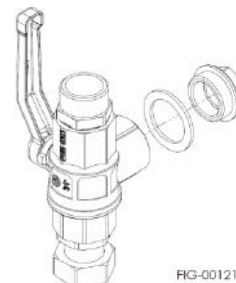

### **32.PERIODIC MAINTENANCE**

To ensure a safe use of the appliance and to extend its working life, it is advisable to have it checked at least once a year by an authorized service centre that will act as follows:

- Replacement of the magnesium anode
- internal inspection of the boiler and possible cleaning of calcium deposited at the bottom of the tank
- check of the gas pipe tightness
- heat exchanger maintenance

### **33.WARRANTY VALIDATION**

The warranty starts from the date of purchase proved by a document valid for tax purposes (invoice or receipt): it is essential in order to take advance of the right to the guarantee.

For further details regarding the warranty terms, see the warranty certificate supplied with your appliance. The guarantee certificate must be stored together with the purchase document (invoice or receipt) and must be shown to the authorized service centre in the event of a warranty claim. The only possession of the appliance does not give right to exercise the guarantee claim.

**IMPORTANT:** Tampering any device factory calibrated and sealed by the manufacturer is absolutely forbidden.

**ATI DI MARIANI SRL**

declares under its own responsibility  
that the product

**the water heater mod.**

**WHC 400**

**WHC 500**

**WHC 700**

**WHC 900**

complies with European directives:

2009/142 / EC - Gas Appliances

2006/95 / EC - Low Voltage Directive

2004/108 / EC - Electromagnetic Compatibility Directive



**ATI DI MARIANI SRL**

**Via E. Mattei, 461 - Zona Ind. No. 4 Torre del Moro**

**47522 Cesena (FC) - ITALY**

**Tel. 0547 609711 Fax 0547 609724**

**[www.atimariani.it](http://www.atimariani.it)**

**[info@atimariani.it](mailto:info@atimariani.it)**

